

Product Data

2ABH Hot Water Driven Absorption Chiller

105 ~ 4571 kW (30 ~ 1300 usRT)



2ABH, Hot water driven Absorption Chillers, Provides Heat Recovery water chilling to Heat Recovery Facilities.

- No CFC's ; environmentally safe
- Quiet, vibration-free operation
- High reliability due to few moving parts

Table of contents

	Page
Model Number Nomenclature.....	2
Features/Benefits.....	2~4
Single-effect Absorption Cycle.....	6
Specification Data.....	7~9
Dimensions & Foundation.....	10~11
Product Specification.....	12~15
Controls.....	16
Communication.....	17
Start-up & Stop Sequence.....	18~19
Control Panel & Electrical Data.....	20~21
Hot Water Control Valve & Insulation....	22~23
Typical Piping & Wiring.....	24

Model Number Nomenclature

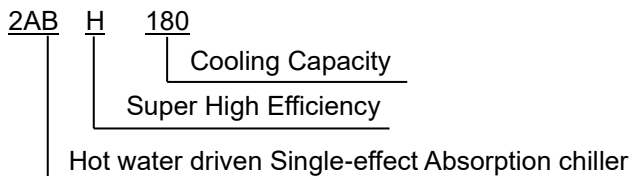

2ABH Hot water driven Absorption Chiller provides economical Water chilling for Cooling from industrial waste heat.

Heat recovery cooling and Excellent part load performance

Exhaust-energy water chilling – 2ABH Hot water driven absorption chiller produces cooling from Exhaust or Solar energy. Also, the use of hot water driven absorption chiller eliminates demand charges and high cost electrical usage and high cost electrical usage.

Application versatility Designed to suit a variety of applications - From comfort cooling to providing chilled water for process applications, the 2ABH absorption chiller offers versatility for almost any job where hot water is available as the heat source, the 2ABH is sure to be the right choice for either new construction or retrofit applications.

Excellent part load performance – 2ABH standard concentration control system allows stable, part load operation at cooling water temperatures as low as 17°C without the need for a cooling water bypass. For maximum efficiency, a variable frequency drive pump (option) automatically maintains optimum solution flow between generator and absorber at all operating condition. This will result in improved part-load efficiency. The 2ABH has a continuous operating range from 100% to 10% of rated machine capacity.

Location and installation savings

Ease of installation – 2ABH Absorption chillers are completely fabricated, assembled and wired in the factory as single-piece units.

Single-point box electrical connection - Installation costs are further reduced by eliminating field wiring between machine components. On units shipped as a single assembly, all unit-mounted electrical items are factory-wired to the chiller microprocessor control panel. Only a single-point electrical connection to the chiller from the building's electrical service is required. Voltage transformers, mounted in the chiller control panel, provide secondary, single-phase powers for the 2ABH control.

Low noise and vibration allows location flexibility - Low sound and vibration levels are characteristic of absorption chillers, primarily due to the fact the only rotating parts are the refrigerant and solution pumps. The overall sound level of 2ABH is typically 75dbA. This allows the machines to be installed near occupiers spaces or in areas with strict sound requirements. Low vibration levels also make it possible to install the chiller on upper floors without special consideration for vibration dampening systems.

Low maintenance

Standard features allow simple maintenance procedures - Every 2ABH machine has numerous standard design features that provide for convenient and simple maintenance. Hinged water box cover on the absorber, and condenser facilitate tube and water box inspection. All moving parts are easily accessible for inspection or replacement, as required.

Leak-proof hermetic pumps cut maintenance costs 2ABH solution and refrigerant pumps/ motors are leak-proof, completely self-contained, and hermetically sealed. The hermetic design eliminates the need for a separate, complicated, and possibly leak-prone seal water system while providing leak tightness and longer machine life. Specially designed bearings absorb both radial and axial thrusts to ensure correct fit at all times. There is no possibility of external contamination since the fluid being pumped lubricates and cools the pump and motor assemblies. In addition, both the rotor and the stator are separated by a stainless steel liner that protects the windings from the fluid being pumped. As an additional safety feature, thermal over-load switches are embedded in the stator to protect against high winding temperatures. The pumps are field serviceable. Inspection is recommended after 5 years or 20,000 hours of operation, whichever comes first. Pump isolation valves are included on 2ABH machines to make field service easy, if required.

Reliable operation (Certification : UL, CE, ISO, PED)

2ABH control system features automatic microprocessor control center continuously monitors machine operation, ensuring precise control - Each 2ABH absorption chiller includes a factory mounted and wired microprocessor control panel that is functionally tested prior to shipment. Continuous monitoring and control of machine operation are performed automatically. A touch screen type display on the front of the control panel identifies operational status and fault indication. All control panel components and the assembly will meet local codes including UL (Underwriters' Laboratories), and KS where appropriate and include a microprocessor CPU (central processing unit) board, molded case circuit breaker, pump contactors, ambient compensated 3-phase pump overload protection, control power transformers, and all other necessary safeties and controls.

As part of the start-up sequence, the chiller microprocessor control panel initiates a self-diagnostic system check to verify that all sensors are in range. Other standard features include a remote start/stop

switch and a key-locked control panel door that protects against unauthorized access.

Superior corrosion protection - Absorption chillers must be protected from the possibility of internal corrosion that is always present when lithium bromide solution is in contact with internal machine surfaces. The 2ABH absorption chiller incorporates a highly effective corrosion inhibitor to provide an extra margin of protection against internal corrosion. Other inhibitors may require the use of exotic tube materials in certain heat exchangers since they are less effective and require frequent maintenance and analysis. The superior corrosion protection of 2ABH's inhibitor allows for the use of standard copper tubes throughout the machine. This results in long machine life and dependable operation.

Gravitational dropping refrigerant and solution distribution system (Evaporator, Absorber, Generator) - The refrigerant and solution distribution system in evaporator, absorber and generator is performed based on gravity and siphon phenomenon. This gravitational dropping distribution system adopts stainless steel tray and allows uniform solution spray and continuous heat transfer. Different from nozzle spray type of distribution system, this system does not need external pumps to spray the solutions with nozzles and prevents nozzles from clogging.

Rugged machine construction - Every 2ABH absorption chiller offers numerous standard features designed to provide reliable, trouble-free operation. The machine is fabricated to meet stringent manufacturing and design requirements and is to ensure product safety and machine integrity.

Automatic purge system extends machine life and ensures optimum efficiency and performance - The purge system of an absorption chiller is critical to ensuring efficient operation and long machine life. Even when machines are vacuum tight or properly inhibited, all absorption chillers generate hydrogen and other non-condensable gases in small quantities. Since these gases are present in sufficient volume to interfere with proper machine operation, they must be removed to protect the unit from internal corrosion, lithium bromide solution crystallization, and/or a reduction in chiller capacity. 2ABH purge system protects the machines from these potential hazards by working continuously during machine operation.

During operation, non-condensable gas tends to accumulate in the absorber section, which operates at the lowest internal pressure. A slip-stream of lithium bromide solution from the solution pump discharge flows through an eductor, creating a suction that draws

non-condensable gas from the absorber. The non-condensable gas is then entrained by the solution flowing through the eductor. The eductor discharges the solution and non-condensable gas into a separator in a purge chamber, where the non-condensable gas are separated from the solution. The non-condensable gas flows to a storage tank, while the solution returns to the absorber.

As non-condensable gas accumulates in the external storage tank, they are isolated from the chiller and

cannot reenter the machine (even during shutdown). These gases must periodically be exhausted (as required) from the storage tank by a simple procedure performed while the machine is running. Evacuation can be performed by a unit-mounted vacuum pump that is connected to the purge evacuation valve.

The unit-mounted vacuum pump can also be used during chiller maintenance or service to remove non-condensable gas directly from the machine.

2ABH OUTLINE

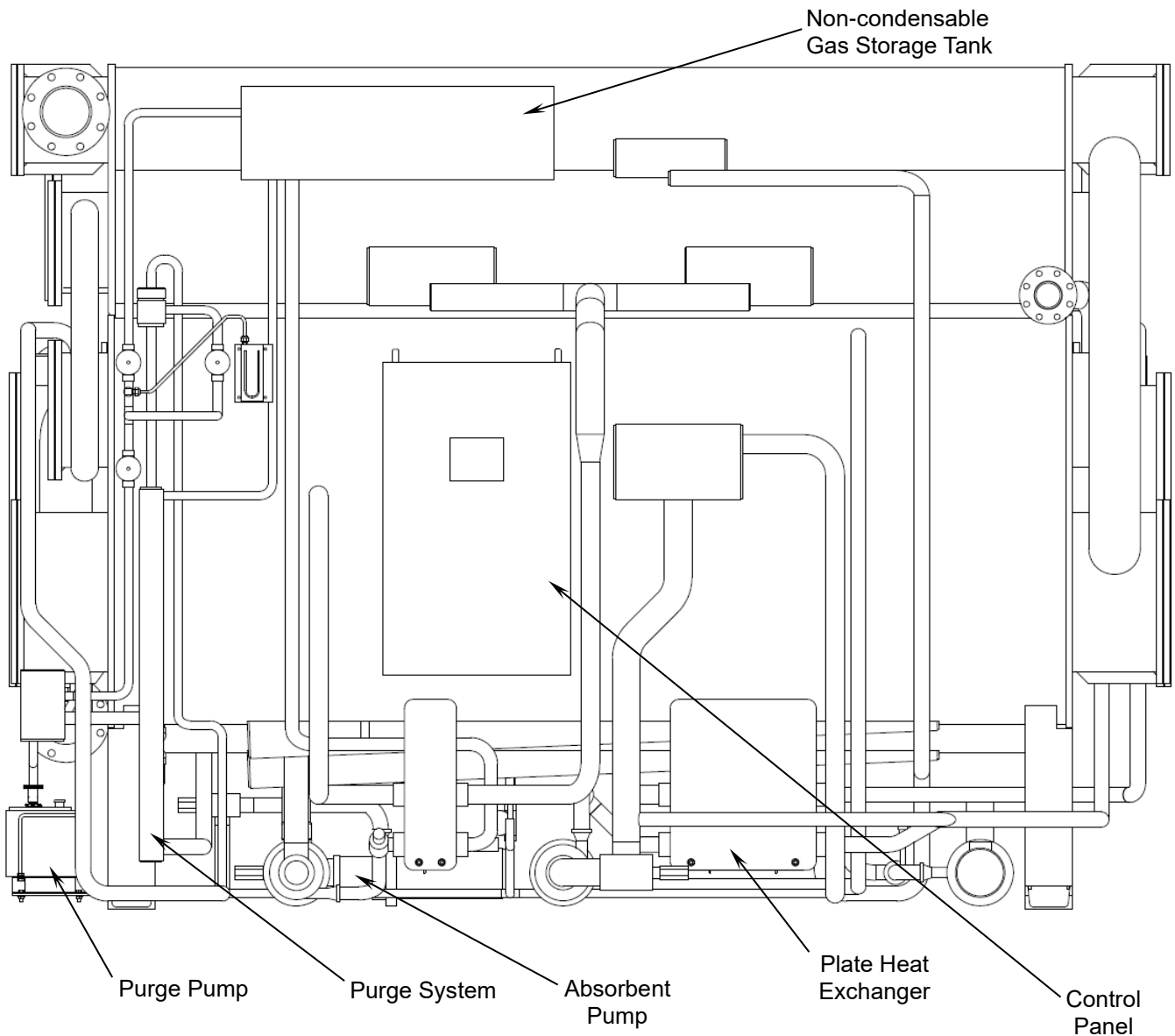

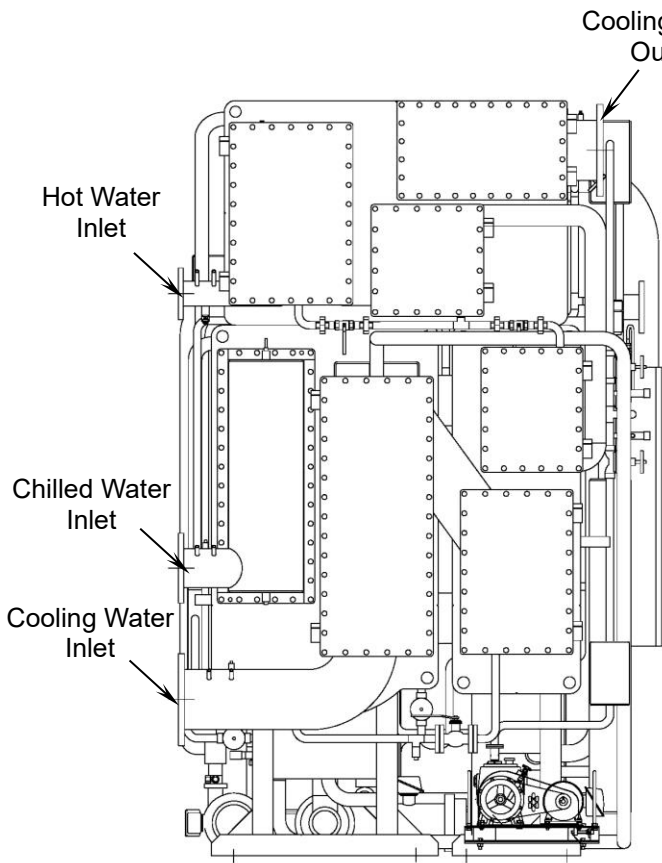

<Left Side View>

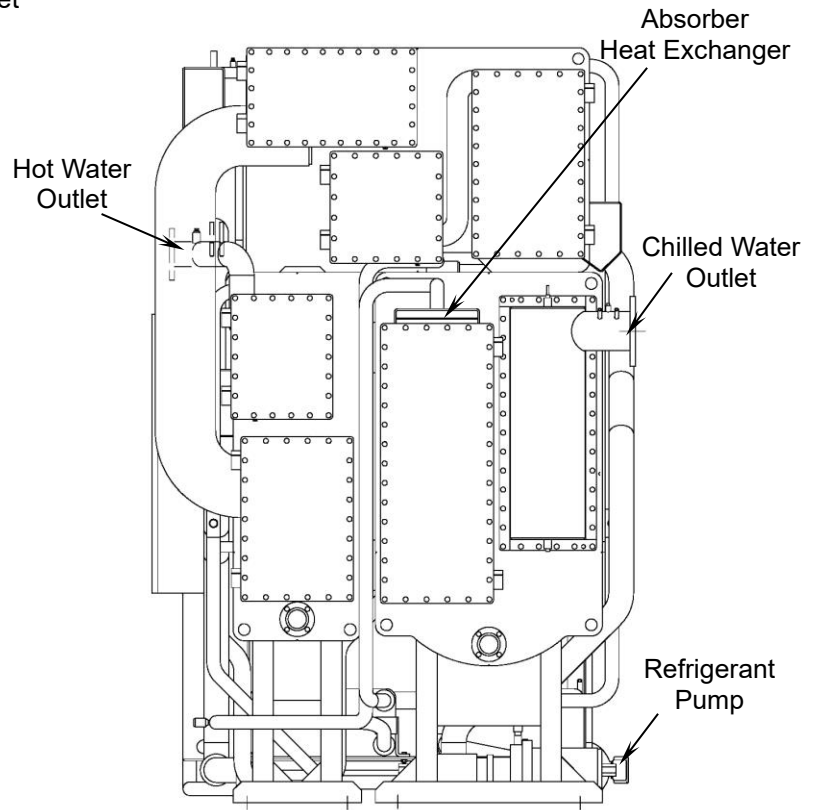

<Right Side View>

Single-effect Absorption Cycle

2-Lift Hot water driven absorption chiller has a main cycle and an aux. cycle. The chilled water is cooled down twice by refrigerant from double tray in the evaporator and the vaporized refrigerant is absorbed into concentrated solution which is coming from 2nd generator. The quantity of Vapor that can be absorbed in the absorber is increased by double tray system. The concentrated solution becomes diluted solution and the heat is absorbed into cooling water. The diluted solution in absorber flows to 1st generator through low temp. heat exchanger and high temp. heat exchanger, and 95°C hot water heats up the diluted solution and refrigerant is vaporized. Absorbent solution becomes intermediate solution in 1st generator and it flows to 2nd generator through high temp. heat exchanger.

The intermediated solution in 2nd generator is heated by hot water and refrigerant is vaporized in 2nd generator. The vapor is absorbed into absorbent solution in aux. absorber to become aux. diluted solution. The aux. diluted solution is delivered to aux. generator through aux. heat exchanger, and the solution is heated by hot water coming from 1st generator and becomes aux. concentrated solution. The aux. concentrated solution is delivered to aux. absorber through aux. heat exchanger. The refrigerant vapors which are generated in the 1st generator and aux. generator are condensed in condenser and then flow into evaporator, and the heat in condenser is absorbed by cooling water.

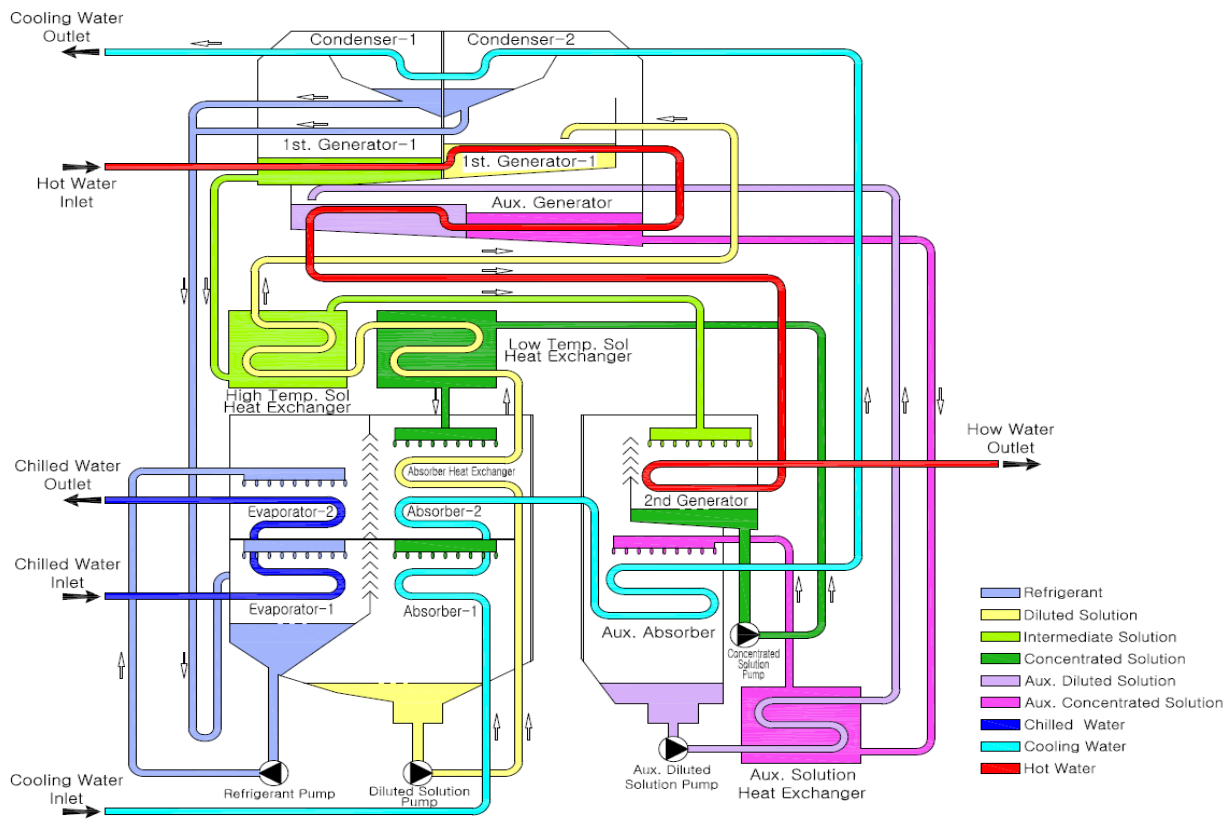

Specification Data (SI unit)

Model		unit	2ABH 30	2ABH 40	2ABH 50	2ABH 60	2ABH 70	2ABH 90	2ABH 110	2ABH 135	2ABH 155	2ABH 180		
Cooling Capacity		kW	105	141	176	211	264	316	387	475	545	633		
		usRT	30	40	50	60	75	90	110	135	155	180		
Chilled water	Temp.	°F	55.4 / 46.4											
	Flow rate	GPM	79.7	106.5	133.0	159.8	199.9	239.5	292.8	359.3	412.5	479.9		
	P. Drop	ftH ₂ O	15.1	17.1	20.0	22.3	22.0	22.6	15.1	16.1	14.8	14.8		
	Connection	Inch	2.5			3			4			5		
Cooling water	Temp.	°F	87.8 / 97.7											
	Flow rate	GPM	173.0	230.7	288.4	346.1	432.8	519.5	634.0	779.3	893.8	1039.1		
	P. Drop	ftH ₂ O	14.4	16.1	24.3	26.6	24.9	26.6	16.1	18.0	18.0	18.7		
	Connection	Inch	4			5			6					
Hot water	Temp.	°F	203 / 176											
	Flow rate	GPM	13.6	18.1	22.9	27.3	34.3	40.9	50.2	61.6	70.9	81.9		
	Pressure Drop	Shell	ftH ₂ O	2.0	3.9	7.2	8.2	7.9	8.5	16.4	17.7	15.1	15.4	
		Control Valve	ftH ₂ O	13.8	6.2	9.5	13.8	8.2	12.1	7.2	11.2	5.9	8.2	
	Connection	Inch	2			2.5			3					
	Control Valve	Inch	0.75	1			1.25			1.5			2	
Electric	Power source	-	3Φ, 460, 60Hz											
	Abs. Pump	kW(A)	2.0 (7.3)				2.1(7.3)				2.4(8.1)			
	Ref. Pump	kW(A)	0.2 (0.9)								0.3(1.2)			
	Purge Pump	kW(A)					0.4 (1.2)							
	Control Panel	kW(A)					0.2 (0.4)							
	Total Power	kW					2.9				3.3			
	Total Ampere	A					9.8				10.9			
Size	Length (L)	Inch	83.0			102.7			104.6			144.8		146.8
	Width (W)	Inch	61.2				62.8				68.2			
	Height (H)	Inch	82.3				97.3				106.5			
Weight	Rigging	lb	6000	6200	7300	7500	9900	10400	13000	13700	16300	1700		
	Operation	lb	6400	7100	8200	8800	11700	12100	15000	15900	19200	20300		
Clearance, Tube Removal	Inch	74.8			94.5			133.9						

General conditions

1. Available max. working pressure of chilled water/cooling water/hot water : 1.0MPa.
2. Fouling factor 0.000044 m² °C/W for Absorber and Condenser, 0.000018 m² °C/W for Evaporator and Generator.

Specification Data (SI unit)

Model		unit	2ABH 210	2ABH 240	2ABH 270	2ABH 300	2ABH 340	2ABH 375	2ABH 420	2ABH 470	2ABH 525	
Cooling Capacity		kW	738	844	949	1,055	1,196	1,319	1,477	1,653	1,846	
		usRT	210	240	270	300	340	375	420	470	525	
Chilled water	Temp.	°F	55.4 / 46.4									
	Flow rate	GPM	559.2	638.4	717.7	796.9	907.0	999.5	1118.3	1250.4	1400.1	
	P. Drop	ftH ₂ O	32.5	31.8	33.5	33.5	30.2	31.8	14.4	19.4	18.4	
	Connection	Inch	5			6			8			
Cooling water	Temp.	°F	87.8 / 97.7									
	Flow rate	GPM	1210.8	1382.5	1558.6	1730.3	1959.3	2161.8	2421.6	2712.2	3029.2	
	P. Drop	ftH ₂ O	34.8	34.1	32.8	32.8	35.4	35.8	21.0	27.9	21.3	
	Connection	Inch	8			10					12	
Hot water	Temp.	°F	203 / 176									
	Flow rate	GPM	96.0	109.6	123.3	136.9	155.0	171.3	191.5	214.4	239.5	
	Pressure Drop	Shell	ftH ₂ O	15.4	15.7	19.7	20.0	17.7	17.7	12.1	16.4	13.1
		Control Valve	ftH ₂ O	11.2	5.2	6.6	8.2	10.5	6.6	8.2	10.2	12.8
	Connection	Inch	3					4				
	Control Valve	Inch	2	2.5				3				
Electric	Power source	-	3Φ, 460, 60Hz									
	Abs. Pump	kW(A)	2.6 (8.1)		3.1 (8.9)		3.2 (8.9)		3.6 (9.7)		6.4(17.0)	
	Ref. Pump	kW(A)	0.3 (1.2)				0.4 (1.2)					
	Purge Pump	kW(A)	0.4 (1.2)									
	Control Panel	kW(A)	0.2 (0.4)									
	Total Power	kW	3.5		4.0		4.2		4.6		7.4	
	Total Ampere	A	10.9		11.8				12.6		19.9	
Size	Length (L)	Inch	186.9		191.1		191.8		213.1	232.8	236.7	
	Width (W)	Inch	68.2		80.6		90.9		91.8		101.9	
	Height (H)	Inch	106.5		109.5		116.0				124.7	
Weight	Rigging	lb	20100	20900	25600	26900	30600	31700	35900	39900	50500	
	Operation	lb	23600	24700	30400	32000	36800	38400	43400	48100	61100	
Clearance, Tube Removal		Inch	181.1						204.7		224.4	

General conditions

1. Available max. working pressure of chilled water/cooling water/hot water : 1.0MPa.
2. Fouling factor 0.000044 m² °C/W for Absorber and Condenser, 0.000018 m² °C/W for Evaporator and Generator.

Specification Data (SI unit)

Model		unit	2ABH 580	2ABH 630	2ABH 750	2ABH 820	2ABH 900	2ABH 975	2ABH 1050	2ABH 1125	2ABH 1300	
Cooling Capacity		kW	2,039	2,215	2,637	2,883	3,165	3,428	3,692	3,956	4,571	
		usRT	580	630	750	820	900	975	1050	1125	1300	
Chilled water	Temp.	°F	55.4 / 46.4									
	Flow rate	GPM	1545.4	1677.5	1998.9	2183.8	2395.2	2597.7	2795.8	2994.0	3460.7	
	P. Drop	ftH ₂ O	24.3	30.2	23.3	29.9	22.6	28.2	17.1	21.0	31.2	
	Connection	Inch	8		10		12					
Cooling water	Temp.	°F	87.8 / 97.7									
	Flow rate	GPM	3346.2	3632.4	4328.0	4728.7	5191.0	5622.5	6058.3	6489.8	7498.1	
	P. Drop	ftH ₂ O	27.6	34.4	28.5	36.1	26.6	33.1	7.9	9.8	14.1	
	Connection	Inch	10		14		16		18			
Hot water	Temp.	°F	203 / 176									
	Flow rate	GPM	264.6	287.5	342.1	374.2	410.3	444.7	479.9	515.1	594.4	
	Pressure Drop	Shell	ftH ₂ O	16.7	20.7	15.1	19.0	15.4	18.7	13.1	16.1	23.3
		Control Valve	ftH ₂ O	7.5	8.9	12.8	7.2	8.9	10.2	11.8	13.8	7.9
	Connection	Inch	4		5			6				
	Control Valve	Inch	4			5					6	
Electric	Power source	-	3Φ, 460, 60Hz									
	Abs. Pump	kW(A)	6.4 (17.0)		7.5 (21.5)		8.5 (24.0)		10.9 (30.2)			
	Ref. Pump	kW(A)	0.4 (1.2)		1.5(1.9)							
	Purge Pump	kW(A)	0.4 (1.2)			0.75 (1.9)						
	Control Panel	kW(A)	0.2 (0.4)									
	Total Power	kW	7.4		9.6	10.0	11.0		13.4			
	Total Ampere	A	19.9		26.4	27.1	29.6		35.8			
Size	Length (L)	Inch	257.4	277.0	261.4	281.1	265.7	285.4	274.3	293.9	333.3	
	Width (W)	Inch	101.9		125.2		145.3		177.5			
	Height (H)	Inch	124.7		136.8		155		157.5			
Weight	Rigging	lb	55600	60400	69700	75800	87300	92600	97900	104700	120600	
	Operation	lb	67200	73200	82500	89700	103400	109600	119000	127400	145500	
Clearance, Tube Removal		Inch	244.1	263.8	244.1	263.8	244.1	263.8	248.0	267.7	307.1	

General conditions

1. Available max. working pressure of chilled water/cooling water/hot water : 1.0MPa.
2. Fouling factor 0.000044 m² °C/W for Absorber and Condenser, 0.000018 m² °C/W for Evaporator and Generator.

Dimensions

2ABH

Unit : Inch

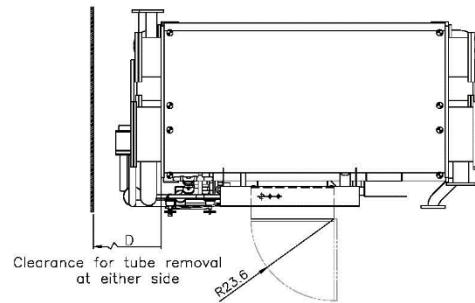

NOTES

1. ● INDICATES THE POSITION OF ANCHOR BOLTS.
2. ALL EXTERNAL WATER PIPING ARE TO BE PROVIDED BY THE CUSTOMER.
3. ↑ INDICATES THE POSITION OF THE POWER SUPPLY WIRING CONNECTIONS TO CONTROL PANEL.
4. INSTALLATION AND SERVICE CLEARANCE AS FOLLOWS:
 LONGITUDINAL DISTANCE : 40 inch
 TOP : 8 inch
 CONTROL PANEL : 47 inch
 OTHERS : 20 inch

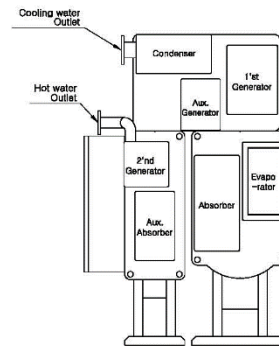
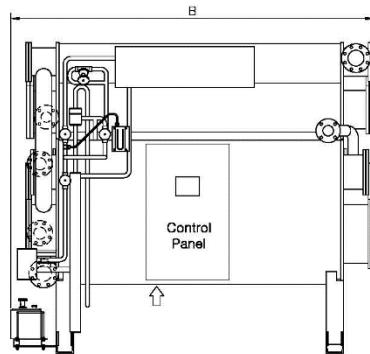
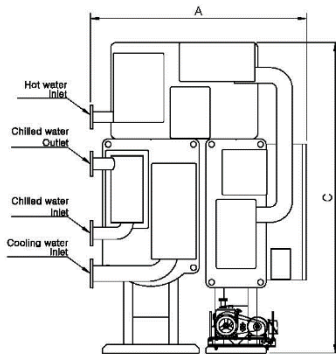

	2ABH 30	2ABH 40	2ABH 50	2ABH 60	2ABH 75	2ABH 90	2ABH 110	2ABH 135	2ABH 155	2ABH 180	2ABH 210	2ABH 240	2ABH 270	2ABH 300
A	61.2			62.8				68.2				80.6		
B	83.1		102.8		104.6		144.8		146.8		186.9		191.1	
C	89.8				97.4				106.5				109.5	
D	74.8		94.5				133.9				181.1			

	2ABH 340	2ABH 375	2ABH 420	2ABH 470	2ABH 525	2ABH 580	2ABH 630	2ABH 750	2ABH 820	2ABH 900	2ABH 975	2ABH 1050	2ABH 1125	2ABH 1300												
A	90.9		91.8		101.9			125.2		145.3			177.5													
B	191.8		213.1		232.8		236.7		257.4		277.0		261.4		281.1		265.7		285.4		274.3		293.9		333.3	
C	116.0				124.7				136.8				155				157.5									
D	181.1		204.7		224.4		244.1		263.8		244.1		263.8		248.0		267.7		307.1							

Foundation

unit : Inch

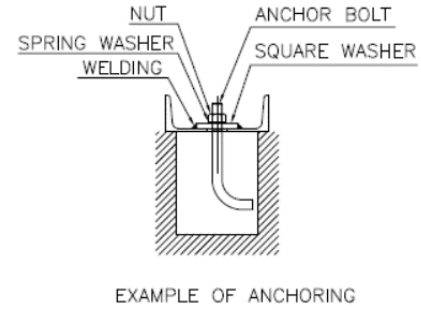
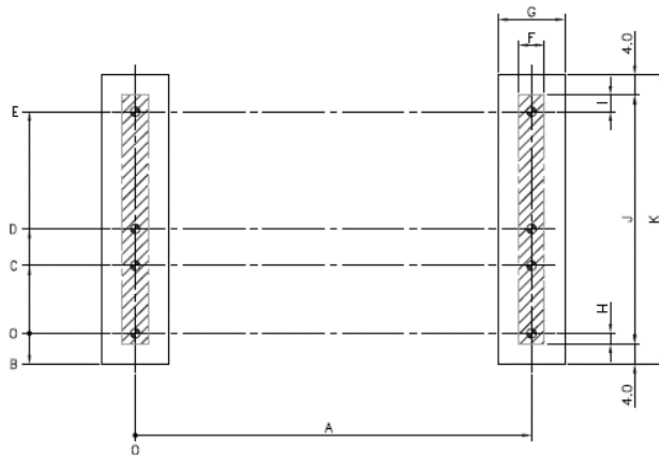

- NOTES
1. THERE SHOULD BE A DRAIN AROUND THE FOUNDATION.
 2. THE FLOOR SURFACE SHOULD BE MADE AS WATER PROOF FOR EASY MAINTENANCE WORK.
(HORIZONTAL LEVEL BELOW 0.01 inch/10 inch)
 3. DIG ANCHOR BOLT HOLES AT THE EXACT LOCATION ACCORDING TO SPECIFICATIONS.
MORTAR CEMENT IS TO BE POURED INTO THEM.
ANCHOR BOLT ARE NOT SUPPLIED WITH THE UNIT.
 4. ■■■■ INDICATES POSITION OF LEG BASE.

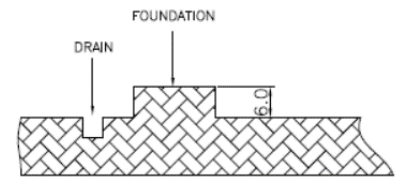

Model	A	B	C	D	E	F	G	H	I	J	K
2ABH30&40	56.7	5.9	13.1	20.2	41.2	4.9	12.8	2.0	3.1	46.3	54.2
2ABH50&60	76.4										
2ABH75&90	116.6										
2ABH110&135	115.6										
2ABH155&180	155.7										
2ABH210&240	153.8										
2ABH270&300	153.8										
2ABH340&375	175.1										
2ABH420	194.7										
2ABH470	192.8	7.9	23.9	33.1	73.6	9.8	17.7	3.9	4.1	81.7	89.5
2ABH525	213.4										
2ABH580	233.1										
2ABH630	211.5										
2ABH750	231.1										
2ABH820	211.5										
2ABH900	231.1										
2ABH975	231.1										
2ABH1050	211.5										
2ABH1125	231.1										
2ABH1300	270.5		46.9	56.9	139.2					147.2	155.1

Product Specification

2ABH Hot water driven Absorption Chiller

Capacity Range: 30 ~ 1300 usRT (105 ~ 4571kW)

1. SYSTEM DESCRIPTION

Electronically controlled, 2ABH series absorption chiller utilizing hermetic refrigerant and solution pumps, lithium bromide solution as the absorbent, and water as the refrigerant. Hot water shall be supplied to the generator as the heat source.

2. QUALITY ASSURANCE

A. Chiller performance shall be rated in accordance with ARI Standard 560 (latest edition).

B. Chiller shall be manufactured in accordance with ANSI/ASHRAE 15 (latest edition), Safety Code for Mechanical Refrigeration or KS B 6271 (Korea Standard), as applicable.

C. Chiller shall be designed and constructed to meet applicable requirements and shall bear CE label (if required).

D. Each chiller shall undergo a series of standard factory tests to ensure that the unit is leak tight, that all electrical components operate as intended, and that every aspect of the unit fabrication meets stringent quality standards in accordance with good practice and the manufacturer's quality assurance requirements.

- 1) The shell side of each chiller shall be leak tested by pressurizing to 76 kPa with nitrogen and then checked by spraying a soap/water mixture on all welds, tube joints, and/or gasket joints to identify any major leaks. Afterward, a mass spectrometer test shall be performed by evacuating the unit to 0.001mmHg absolute, covering the machine with a vinyl tent, and introducing helium gas under the tent. Any remaining leaks will allow the helium to be drawn into the shell side of the machine. The acceptable leak rate as measured by the mass spectrometer test shall not exceed 0.00001 cc/sec standard air.
- 2) The tube side of the evaporator, absorber, generator and condenser shall be hydrostatically tested at 1.5 times rated design pressure and held for 30 minutes.
- 3) The refrigerant and solution pump/motors shall undergo standard factory tests to ensure proper head flow, and motor output characteristics.
- 4) All machine wiring shall undergo an

insulation resistance test. The chiller control center and all electrical components shall also be functionally tested to verify continuity and proper electrical operation.

- 5) Final assembly inspection shall consist of verifying that all valves, controls, instrumentation, pumps, purge components, and all other machine components have been properly installed on the machine.
- 6) Each unit shall be checked for overall appearance and dimensional accuracy.
- 7) Final inspection shall be performed on each unit to check that painting of the unit is as specified, name-plate data is correct, and that all accessories are furnished as required.

3. EQUIPMENT

A. General:

Absorption chiller shall include evaporator, absorber, condenser, generator, solution heat exchanger, absorber heat exchanger, refrigerant/solution pumps, purge system, piping, wiring, controls and auxiliaries. Shipment of the machine shall be in one piece. Initial charge of lithium bromide can be included with the chiller for charging at the jobsite.

B. Heat Exchangers:

- 1) All heat exchangers shall be of shell and tube construction with shells, tube sheets, tube support sheets, and water boxes fabricated of carbon steel. All heat exchangers shall incorporate straight tubes. All tubes for generator, absorber, evaporator, condenser are expanded into grooved tube sheet.
- 2) Water boxes.
The evaporator, absorber, condenser and generator water boxes shall be designed for 1034 kPa working pressure. Nozzle-in-head (NIH) type water boxes shall be supplied on the evaporator while the absorber-condenser and generator water boxes shall be marine type. All water boxes shall be provided with vent and drain connections. ANSI 150 psig RF flanges shall be furnished on all water box nozzle connections.

* Special coating will be applied inside of the water box In case when salted water is used.

- 3) Plate heat exchanger.

A solution heat exchanger shall be an integral part of the machine to increase efficiency by pre-heating weak solution on the tube side with strong solution on the shell side. The plate heat exchanger is made SUS316L to prevent corrosion. Plate heat exchanger is built-up by a plate package of corrugated channel plates surrounded by front and rear cover plate packages. The heat plate makes channel passing two kinds of fluid. The corrugated shape formed on heat plate makes fluid turbulence and supports plates against pressure difference between two fluids.

- 4) Absorber heat exchanger.
Absorber heat exchanger is newly added in 2ABH series absorber, so efficiency of 2ABH series is much greater than the previous series.
- 5) Tray and dripper system.
Tray and dripper system for the evaporator, absorber, and generator shall be of a non-clogging design, specifically designed for the intended duty, and shall be fabricated of a corrosion-proof material to ensure continuous, high-efficiency operation. Evaporator and absorber of World energy 2ABH series has double tray and dripper system, chiller capacity is greatly increased By this system.
- 6) Material.
Heat exchanger material and minimum wall thickness shall be contingent on the type of corrosion inhibitor used in the machine. For lithium molybdate systems, the following tube specifications shall apply to ensure long machine life and continuous operation:

Evaporator..... Copper or STS
 Absorber..... Copper or STS
 Condenser. Copper or STS
 Generator..... Copper or STS

* Special tube material like Cupronickel, Titanium can be used as an option, if required.

C. Pump/Motors:

Refrigerant and solution pump/motors shall be self-contained, leakproof, hermetic type, with isolation valves, and internal seal water system to minimize air leakage into the machine. Lubrication and cooling shall be

accomplished by the fluid being pumped; auxiliary water piping for cooling and lubrication shall not be acceptable. Pump/motor assemblies shall be designed for a minimum of 5 years (or 20,000 hours) normal operation between inspections.

D. Purge System

An automatic purge system shall be furnished to provide a continuous purging action whenever the chiller is in operation to assure long machine life and efficient performance. Non-condensable gas shall be removed from the absorber by a liquid eductor, which shall use flow from solution pump to create a suction. Non-condensable gas shall be stored external to the unit and shall be prevented from diffusing back into the machine when the unit is not operating. Evacuation of the external storage tank shall be accomplished by the use of a unit-mounted vacuum pump. The vacuum pump shall be factory mounted on the chiller and wired to the control panel by the chiller manufacturer.

E. Controls:

1) General

The Hot water absorption chiller contains a microprocessor-based control panel that monitors and controls all operations of the machine. The microprocessor controls system matches the cooling capacity of the machine to the cooling load while providing state of machine protection. The system controls cooling capacity within the set point plus the dead band by sensing the leaving chilled water and regulating the hot water control valve via a mechanically linked actuator motor.

The control system controls the operation of the machine by monitoring all operating conditions. The microprocessor control panel can diagnose a problem and let the operator know what the problem is and what to check. It promptly positions the hot water control valve to maintain leaving chilled water temperature. It can interface with auxiliary equipment such as pumps and cooling tower fans. It continually checks all safeties to prevent any unsafe operating condition.

2) Safety Control

The Control panel monitors all safety control inputs and if required shuts down the chiller or stops solution pump to protect

the chiller from possible damage from any of the critical conditions. The controller screen displays the messages if the controller starts safety controls to stop, the alarm relay operates and alarm indicator is brink. The alarm is saved in the controller alarm table to correct the problems.

- 3) Remote Start/Stop Control
A remote device, such as a time clock which uses a set of contacts, may be used to start and stop the chiller.
- 4) Spare Safety Inputs
Normally closed (NC) digital inputs for additional field-supplied safeties may be wired to the spare protective limits input channel in place of the factory-installed jumper. (Wire multiple inputs in series.)
The opening of any contact will result in a safety shutdown and controller display.
- 5) Tower-Fan Relay
The tower-fan relay can be controlled when cooling water inlet temperature is low. The temperature setting point is adjustable in the range 16 ~ 30 °C (60.8 ~ 86 °F).
- 6) Auto Restart After Power Failure
If the control power is interrupted during operation, the chiller stops immediately without the normal shutdown sequence and dilution. Solution crystallization can occur if the concentration is high (chiller was operating with a relatively large load). The machine will start automatically when the power is back on.

F. Machine Safety Devices:

- 1) Machine safety and limit devices shall be included as follows:
 - a. Low chilled water temperature
 - b. Low chilled water flow
 - c. Low cooling water flow (optional)
 - d. High Generator temperature
 - e. High motor winding temperature – refrigerant / solution pumps
 - f. High motor amperage – refrigerant / solution pumps

G. Electrical Requirements:

- 1) Power supply to the unit shall be 3-ph, 60Hz with voltages of 380, 400, 440, 460 / 3-ph, 50Hz with 380V, 400V, 440V, 460V as specified on the equipment schedule. A multi-tap transformer shall provide 24V single-phase and 24 DC secondary power for the control panel
- 2) Contractor shall supply and install the electrical power line and all auxiliary

electrical protection devices per local code requirements and as indicated necessary by the chiller manufacturer.

- H. Contractor shall supply and install electrical wiring and devices required to interface the chiller controls with the building control system, if applicable.

I. Piping Requirements:

- 1) Piping and instrumentation for the chilled water, cooling water and hot water shall be supplied and installed by the contractor / owner.
- 2) Chilled water flow switch shall be factory supplied and factory installed in the evaporator water nozzle. Cooling water flow switch shall be field installed or factory installed if customer requires and supplied by either the chiller manufacturer or the contractor/owner.

J. Thermal Insulation:

Insulation of cold or hot surfaces shall be field supplied and field installed on the machine. Chiller manufacturer shall specify the recommended material and surface area to be insulated.

K. Sound Level:

The overall sound pressure level of the chiller shall not exceed 75 dbA when measured per ARI Standard 575 (latest edition).

L. Start-up:

- 1) Unit manufacturer shall provide a factory-trained service representative, employed by the chiller manufacturer, to perform and/or supervise chiller pressure test (when required), charge chiller with refrigerant (water) and lithium bromide solution, place unit into operation, and calibrate all controls in accordance with the manufacturer's written start-up, operating, and maintenance instructions.
- 2) After unit start-up has been performed, the same factory representative shall be available for a period of instruction (not to exceed 4 hours) to instruct the owner's personnel in the proper start-up, operation, and maintenance procedures.
- 3) Manufacturer shall provide the following literature:
 - a. Installation Instructions
 - b. Start-up, Operating and Maintenance Instructions
 - c. Field Wiring Diagrams

Options and Accessories:

- 1) High-Pressure Water boxes:
Water boxes rated for 1724 kPa or 2068 kPa working pressure shall be furnished when specified on the equipment schedule.
- 2) Special Tubing:
Tubing of non-standard materials and/or wall thickness shall be provided when specified on the equipment schedule.

- 3) Isolation Package:
A vibration isolation package consisting of machine soleplates and neoprene isolation pads shall be furnished for field installation when specified on the equipment schedule.
- 4) Cooling Water Flow Switch:
A cooling water flow switch, rated for either 1034 kPa or 2068 kPa shall be field installed or factory installed if customer requires and supplied by either the chiller manufacturer or the contractor/owner.

Controls

Programmable Logic Controller is factory mounted, wired and tested to ensure a protection of the Machine and efficient capacity control. The program logic provides proper Start/Stop of the Machine and also enables a communication interface with others.

Component Test and Diagnostic Check

- Touch Screen Interface for Status Display, Set-point Control, and System Configuration
- Primary and Secondary Status Messages
- Individual Start/Stop Schedules for Local Mode
- Recall of Up to 200 Alarm and Alert Messages with Diagnostic Help
- Extensive Diagnostic and Service Capabilities
- Advanced Crystallization Protection

Safety Cutouts

- Solution Pump Motor Overload/High Temperature
- Refrigerant Pump Motor Overload/High Temperature
- Low Chilled Water Outlet Temperature Cutout
- Low Refrigerant Temperature Cutout
- Low Cooling Inlet Temperature Cutout
- Low Chilled Water Flow Cutout
- Low Cooling Water Flow Cutout (Option)
- High G1 Absorbent Temperature Cutout
- High Hot Water Inlet Temperature Cutout
- Emergency Stop

Protective Limits

- Max. Allowable Cooling Water Inlet Temperature
- Max. Allowable G1 Absorbent Temperature
- Max. Allowable Hot Water Inlet Temperature
- Max. Allowable Absorbent Concentration
- Low Chilled Water Temperature

Temperature Sensor Faults

- Chilled Water Outlet Temperature
- Cooling Water Inlet Temperature
- Refrigerant Condensate Temperature
- Refrigerant Evaporating Temperature
- Generator Absorbent Temperature
- Hot Water Inlet Temperature

Capacity Control

- Chilled Water Outlet Temperature Control
- Running Travel Limit (Control Valve Opening Limit)

Indications

- Chiller Operating Status Message
- Absorption Cycle State Points
- Dilution Cycle
- Power-On
- Alarm
- Safety Shutdown Message
- Run Hours
- Control Valve Position



SIEMENS POL635 Controller



LCD Touch Screen



Control Panel

Communication

1. MODBUS-RTU

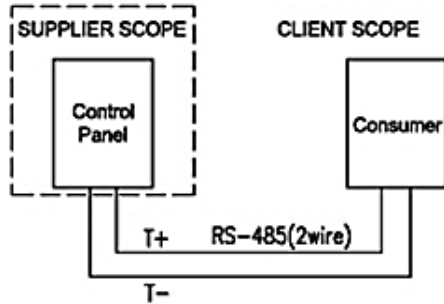

4. BACnet

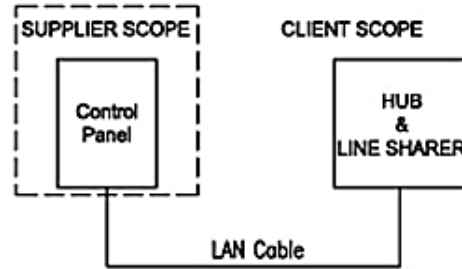

2. MODBUS-TCP

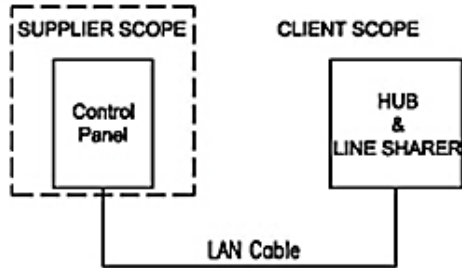

5. INTERNET

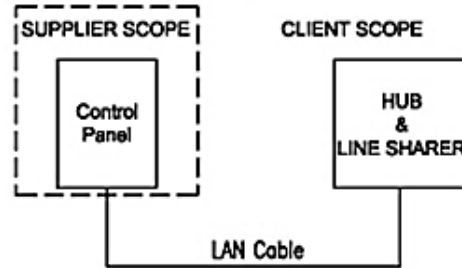

3. PROFIBUS

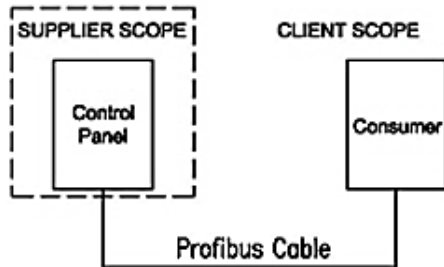

Start-up Sequence

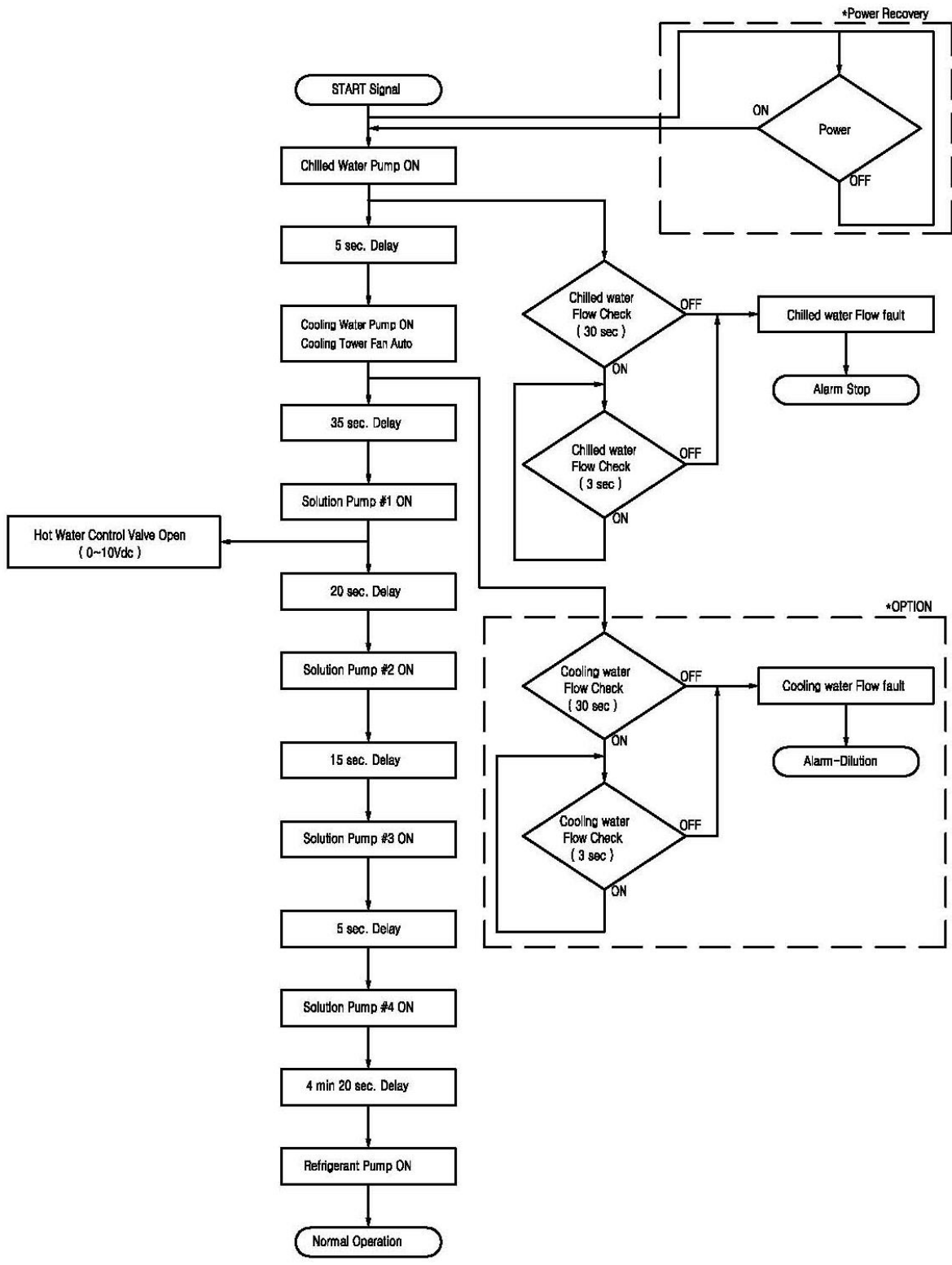

Stop Sequence

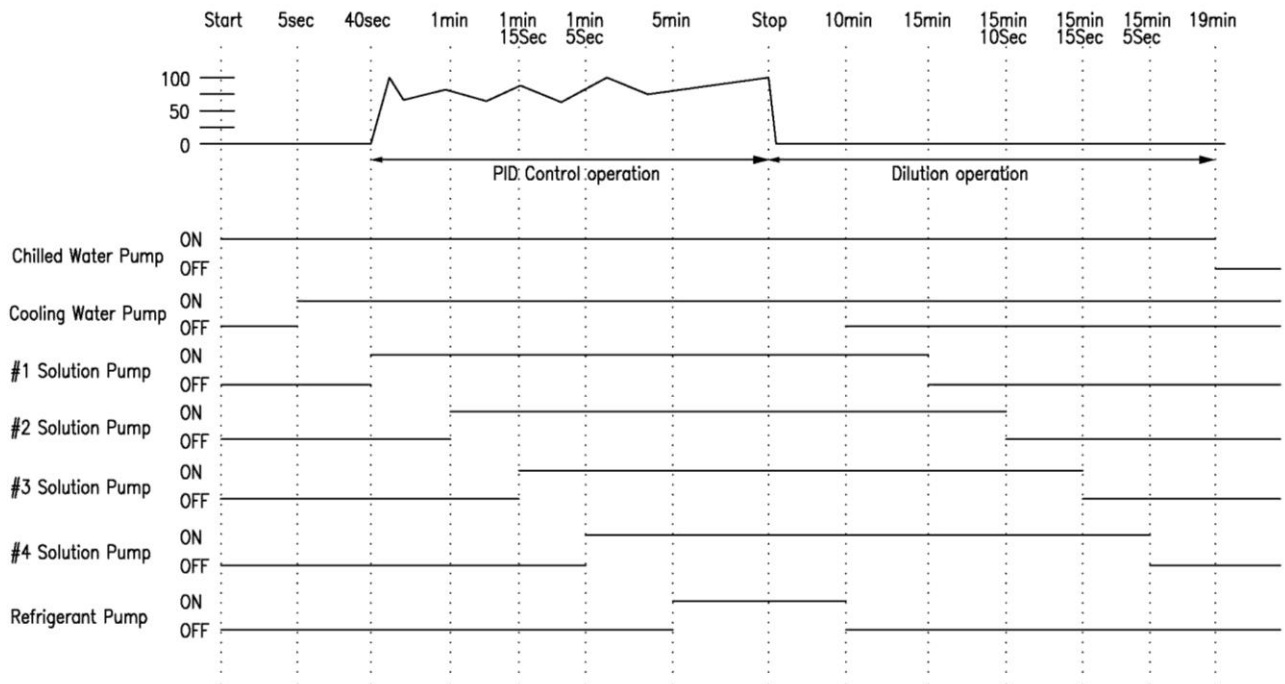
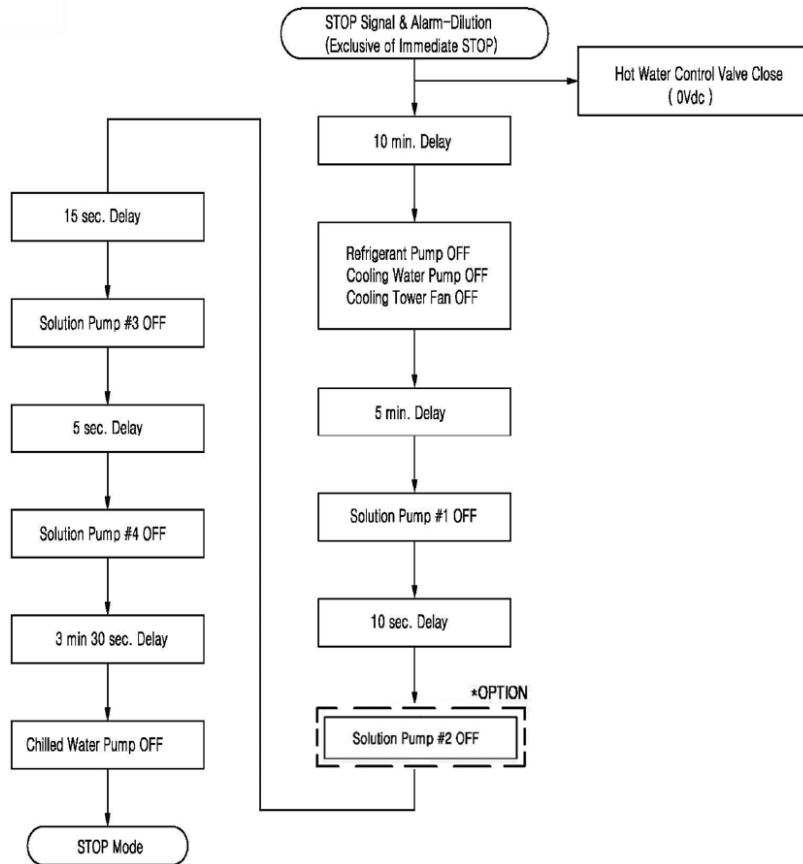

<Operation Graph>

Control Panel – Outside View

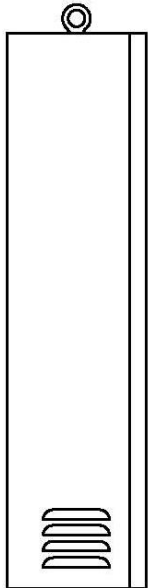

LEFT SIDE VIEW

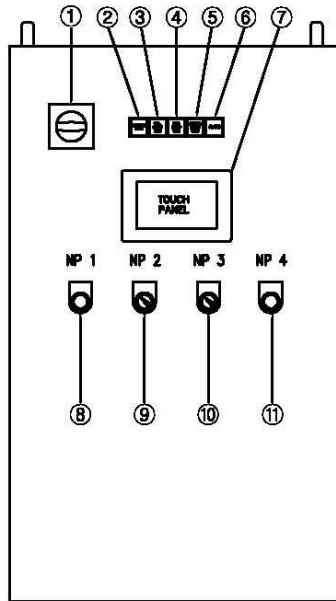

FRONT VIEW

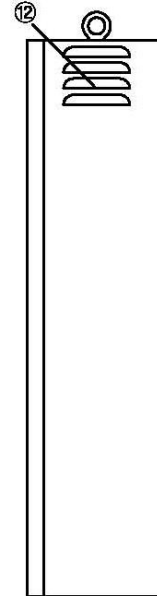

RIGHT SIDE VIEW

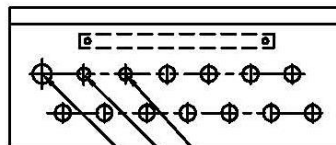

- FOR HOT WATER CONTROL VALVE SIGNAL HOLE
- FOR HOT WATER CONTROL VALVE POWER HOLE
- MAIN POWER HOLE

BOTTOM VIEW

NO.	SYMBOL NAME	DESCRIPTION
1	Q1	DISCONNECT SWITCH
2	LT1	SYSTEM RUN LIGHT
3	LT4	SOLUTION PUMP LIGHT
4	LT3	REFRIGERANT PUMP LIGHT
5	LT5	PURGE PUMP LIGHT
6	LT2	TOTAL ALARM LIGHT
7	TOP	TOUCH OPERATION PANEL
8	BZ	BUZZER
9	S1	BUZZER ON/OFF SELECTOR SWITCH
10	S2	PURGE PUMP START/STOP SELECTOR SWITCH
11	S3	EMERGENCY STOP
12	CF	COOLING FAN

Control Panel - Inside View

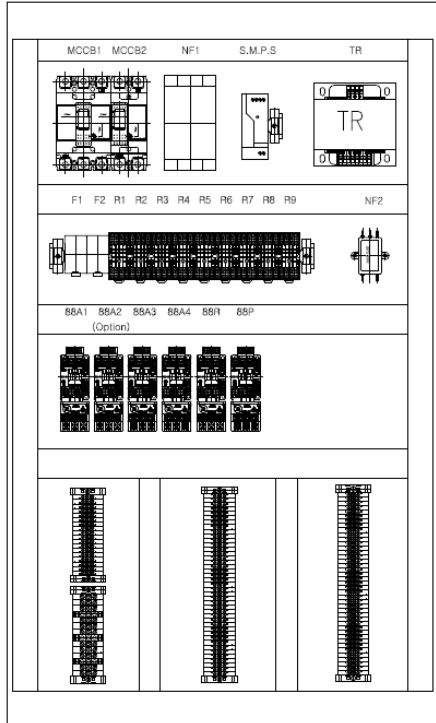

No.	SYMBOL	DESCRIPTION	Q'TY
1	MCCB1	CIRCUIT BREAKER	1
2	MCCB2	CIRCUIT BREAKER	1
3	S.M.P.S	CIRCUIT BREAKER	1
4	TR1	CIRCUIT BREAKER	1
5	NF1 ~ NF2	CIRCUIT BREAKER	2
6	F1 ~ F2	DC POWER SUPPLY	2
7	R1 ~ R9	TRANSFORMER	9
8	88A1	SOLUTION PUMP1 CONTACTOR	1
9	88A2(OPTION)	SOLUTION PUMP2 CONTACTOR	1
10	88A3	SOLUTION PUMP3 CONTACTOR	1
11	88A4	SOLUTION PUMP4 CONTACTOR	1
12	88R	REFRIGERANT PUMP CONTACTOR	1
13	88P	PURGE PUMP CONTACTOR	1
14	TB1	TERMINAL BLOCK	1

Electric Data

Models	460V - 3P- 60Hz																	
	Pump motor size (kW)						RLA (A)						LRA (A)					
	SP1	SP2	SP3	SP4	RP	VP	SP1	SP2	SP3	SP4	RP	VP	SP1	SP2	SP3	SP4	RP	VP
2ABH30~2ABH60	1.2	0.3	0.3	0.3	0.2	0.4	3.3	1.3	1.3	1.3	0.9	1.4	12.0	4.2	4.2	4.2	3.3	4.2
2ABH75~2ABH135	1.2	0.3	0.3	0.3	0.2	0.4	3.3	1.3	1.3	1.3	0.9	1.4	12.0	4.2	4.2	4.2	3.3	4.2
2ABH155~2ABH180	1.5	0.3	0.3	0.3	0.3	0.4	4.1	1.3	1.3	1.3	1.2	1.4	16.8	4.2	4.2	4.2	4.2	4.2
2ABH210~2ABH240	1.5	0.4	0.4	0.3	0.3	0.4	4.1	1.3	1.3	1.3	1.2	1.4	16.8	2.8	2.8	2.8	4.2	4.2
2ABH270~2ABH300	2.0	0.4	0.4	0.3	0.3	0.4	5.0	1.3	1.3	1.3	1.2	1.4	26.0	2.8	2.8	2.8	4.2	4.2
2ABH340~2ABH375	2.0	0.4	0.4	0.4	0.4	0.4	5.0	1.3	1.3	1.3	1.2	1.4	26.0	3.0	3.0	3.0	4.2	4.2
2ABH420~2ABH470	2.4	0.4	0.4	0.4	0.4	0.4	5.8	1.3	1.3	1.3	1.2	1.4	21.0	3.0	3.0	3.0	4.2	4.2
2ABH525~2ABH680	3.0	1.5	1.5	0.4	0.4	0.4	7.4	4.1	4.1	1.3	1.2	1.4	24.0	17.2	17.2	17.2	4.2	4.2
2ABH750	3.0	1.5	1.5	1.5	1.5	0.4	9.1	4.1	4.1	4.1	3.3	1.4	36.0	15.1	15.1	15.1	16.0	4.2
2ABH820	3.0	1.5	1.5	1.5	1.5	0.75	9.1	4.1	4.1	4.1	3.3	2.2	36.0	15.1	15.1	15.1	16.0	10.6
2ABH900~2ABH975	3.0	2.0	2.0	1.5	1.5	0.75	9.1	5.4	5.4	4.1	3.3	2.2	36.0	27.9	27.9	27.9	16.0	10.6
2ABH1050~2ABH1300	4.5	2.2	2.2	2.0	1.5	0.75	13.2	5.8	5.8	5.8	3.3	2.2	79.8	30.2	30.2	30.2	17.2	10.6

LEGEND : SP1 - Solution Pump1, SP2 – Solution Pump2, SP3 - Solution Pump3, SP4 – Solution Pump4,
 RP - Refrigerant Pump, VP - Vacuum Pump , RLA - Rated Load Amps, LRA - Locked Rotor Amps
 Notes : RLA = Listed RLA x (listed voltage/actual voltage), LRA = Listed LRA x (listed voltage/actual voltage)

Hot Water Control Valve

The two-way hot water control valve is supplied from factory. But, this hot water control valve is installed in the outlet(or inlet) line of hot water at jobsite. The valve has a gray cast iron body with DIN type flanged end connections. The valve size is changed 1 to 6 in., depending on the machine model or the specific job requirements. The electric actuator of valve is operated with 24Vac and controlled with 0 to 10Vdc signal. The electric power and the control signal are supplied from the chiller control panel. The hot water pipes have to be correctly connected according to the flow direction marked at the side of valve body, whether it is used as mixing type or diverting type.

* The 2-port valve for use with all actuators.

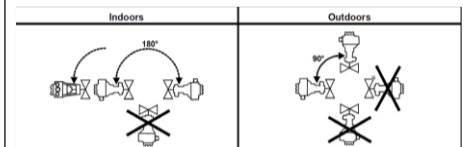
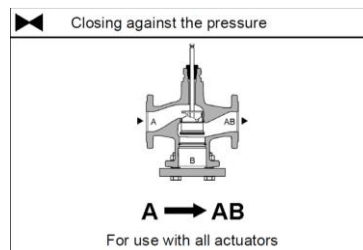
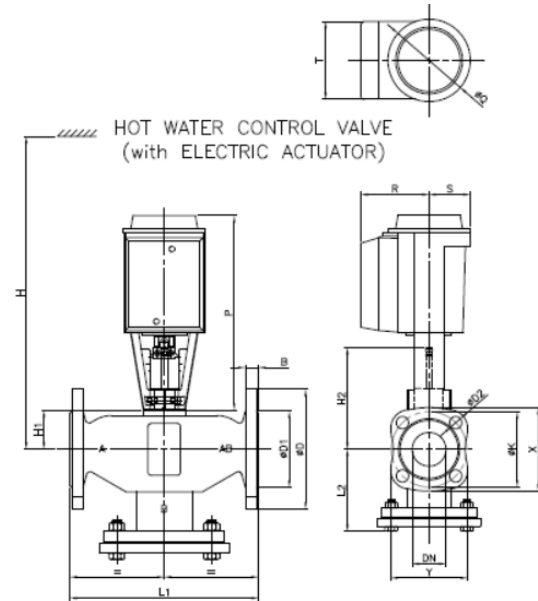

Hot Water Control Valve Dimensions (unit : inch)

DN	B	D	D1	D2	L1	L2	X	Y	K	H1	H2	H	P	Q	R	S	T
1/2	0.55	3.74	1.81	0.55(4x)	5.12	3.39	3.11	2.99	2.56	1.46	5.26	>21.14	11.8	5.0	4.1	2.5	4.7
3/4	0.63	4.13	2.56		5.91	3.82	3.41	3.27	2.95								
1	0.55	4.53	2.56		6.30	4.19	3.72	3.55	3.35								
1 1/4	0.67	5.51	2.99	0.75(4x)	7.09	4.69	4.55	4.36	3.94	1.97	5.77	>21.65	11.8	5.0	4.1	2.5	4.7
1 1/2	0.63	5.91	3.31		7.87	4.96	4.85	4.64	4.33								
2		6.50	3.90		9.10	5.67	5.32	5.06	4.92								
2 1/2	0.67	7.28	4.65	0.75(8x)	11.42	6.85	5.91	5.61	5.71	2.95	6.75	>22.64	14.8	7.0	5.4	3.5	5.0
3		7.87	5.20		12.20	7.32	-	-	6.30								
4		8.66	6.14		13.78	8.07	-	-	7.09								
5	0.67	9.84	7.24	0.91(8x)	15.75	9.17	-	-	8.27	4.84	9.43	>27.48	14.8	7.0	5.4	3.5	5.0
6		11.18	8.31		18.90	10.85	-	-	9.45								



Thermal Insulation – Surface Area

The cold and hot machine surfaces have to be thermally insulated after the initial operation at jobsite. Thermal insulation drawings will be submitted in details. Non-inflammable Polymer sponge usable at 120°C or incombustible Glass wool should be used for cold and hot surfaces. When glass wool is used, it is wrapped with thin aluminum plate or

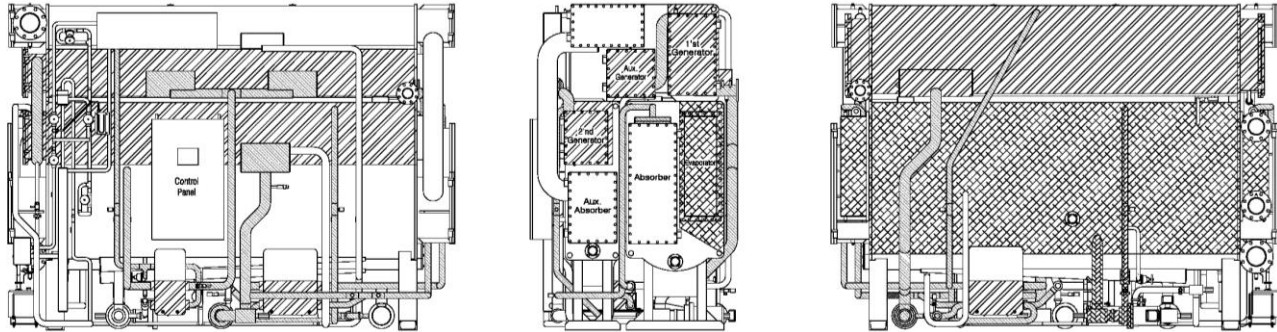

galvanized steel plate. The motor section of refrigerant pump is not insulated and the insulations on water box sections should be disassembled for the repair. The final finish painting is performed after the insulation work. The insulation work and the final finishing paint could be performed as the optional works after factory testing.



1. INSULATION FOR HOT SURFACES

 0.74inch : 1st Generator Body and it's Water Box
 2nd Generator Body and it's Water Box
 Aux. Generator Body and it's Water Box
 High, Low, AUX Heat Exchanger Body
 0.39inch : Pippings of High Temperature's Parts.

2. INSULATION FOR COLD SURFACES

 0.74inch : Evaporator Body and it's Water Box
 0.39inch : Inlet and Outlet Piping of Refrigerant Pump

Model	Hot Surface (pt ²)		Cold Surface (pt ²)	
	0.74 inch	0.39 inch	0.74 inch	0.39 inch
2ABH30	123.8	47.4	35.5	6.5
2ABH40	124.9	54.9	35.5	6.5
2ABH50	138.9	47.4	38.8	6.5
2ABH60	139.9	54.9	38.8	6.5
2ABH75	91.5	64.6	45.2	7.5
2ABH90	91.5	64.6	45.2	7.5
2ABH110	122.7	64.6	61.4	7.5
2ABH135	122.7	64.6	61.4	7.5
2ABH155	141.0	68.9	66.7	9.7
2ABH180	141.0	68.9	66.7	9.7
2ABH210	178.7	73.2	84.0	10.8
2ABH240	178.7	73.2	84.0	10.8
2ABH270	200.2	96.9	92.6	11.8
2ABH300	200.2	96.9	92.6	11.8
2ABH340	233.6	114.1	110.9	11.8
2ABH375	233.6	114.1	110.9	11.8
2ABH420	271.3	134.5	152.8	14.0
2ABH470	294.9	134.5	170.1	15.1
2ABH525	317.5	134.5	181.9	15.1
2ABH580	354.1	158.2	185.1	24.8
2ABH630	377.8	158.2	202.4	24.8
2ABH750	400.4	158.2	219.6	24.8
2ABH820	438.1	172.2	221.7	26.9
2ABH900	461.8	172.2	240.0	26.9
2ABH975	484.4	172.2	240.0	26.9
2ABH1050	508.1	181.9	306.8	29.1
2ABH1125	533.9	181.9	321.8	29.1
2ABH1300	560.8	181.9	338.0	29.1

Typical Piping & Wiring

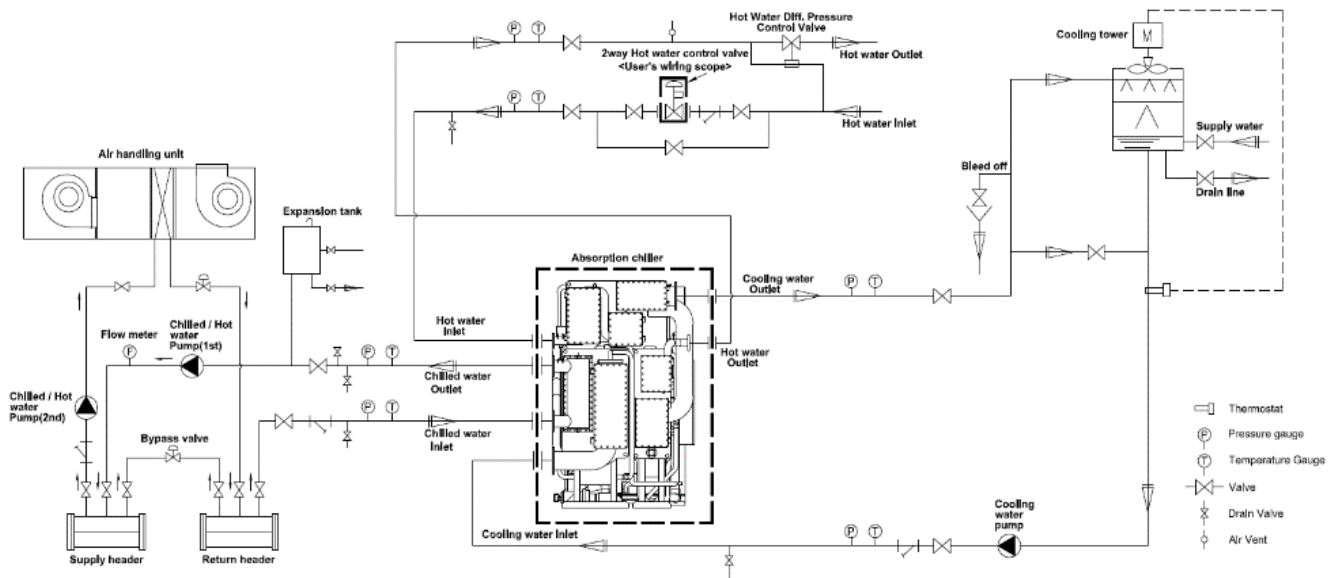

- 1) All external equipment out of dotted line(- - -) shall not be prepared and provided by Absorption Machine Manufacturer.
- 2) For pipe connections and diameters, please refer to the outline and specification data sheet
- 3) Driving hot water must be maintained as design temperature.
- 4) The stop valves at hot water inlet and outlet pipe shall be installed.
- 5) The locations of the chilled water pumps, cooling water pumps and expansion tanks shall be determined in consideration of the hydrostatic head of pumps and the height of building. And the Machine shall not be subject to a pressure larger than the designed pressure at any water headers.
- 6) For cooling water quality control, it is recommended to install cooling water bleed-off device on the inlet pipe line of cooling tower and higher than the water sump level of cooling tower.
- 7) About 10 meshes of strainers shall be installed in the cooling water line.
- 8) For the maintenance and the inspection of the Machine, the following equipment shall be installed on each chilled water and cooling water inlet/outlet lines as well as stop valve.
 - Thermometers and pressure gauges at chilled and cooling water inlet/outlet.
 - Air relief valves shall be installed on each chilled and cooling water lines and at the highest points of each piping.
 - Drain valves at the lowest position between the stop valves of chilled, cooling water and the Machine water box and the drain valve shall be piped to the drain ditch.
- 9) It should be better that a sufficient clearance for access to water box of the absorber, evaporator, condenser, and generator to facilitate inspection and cleaning work.



<Factory Test Facility>

World Energy Co., Ltd

2F, 10, Daeya 1-ro, 24beon-gil, Gunpo-si,

Gyeonggi-do, 435-060, Korea

Tel. : 82-31-501-2704

Fax. : 82-31-501-2705

All contents subject to change without prior notice