

## Product Data



# Double Effect Exhaust Gas Driven Absorption Machine

## CHPHH Series

50 ~ 1,500 usRT (176 ~ 5,274 kW)



**CHPHH Series**, Double Effect Exhaust Gas Driven Absorption Machine consuming flue gas from the engine or turbine, provides the best solution for most efficient waster-heat-recovered cooling and heating.

- No CFC's and environmentally safe
- Direct Cooling & Heating with wasted flue gas from Engine or turbine
- Low Noise & Low vibration operation
- Cost-Effective Cooling & Heating
- Low Maintenance Cost
- Saving of Initial Investment
- Simple Chiller System Configuration
- High Reliability

<b>Table of contents</b>	
Features .....	1
Absorption Cycle .....	2~3
Component Arrangement .....	4
Product Specifications .....	5~8
Performance Data .....	9~12
Control System .....	13~14
Communication .....	15
Start-up & Stop Sequence .....	16~17
Control Panel .....	18~19
Diverter valve .....	20
Installation Guide .....	21
System Piping .....	22
Thermal Insulation .....	23
Water Quality .....	24

**Model Name Nomenclature**

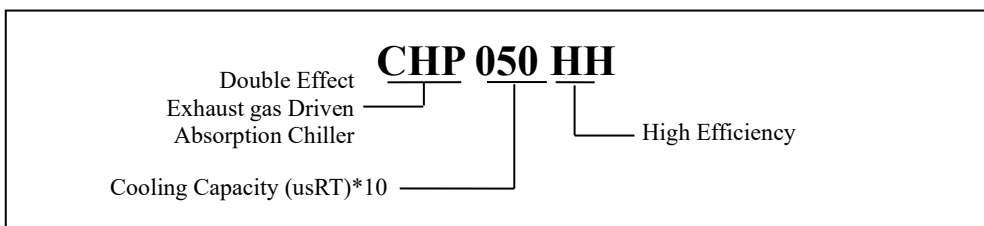

*We reserve the right to modify, change or discontinue the data or design without prior notice*

# Features

**CHPHH Series, Double Effect Direct Fired Absorption Machine, is an excellent solution for maximizing an energy efficiency of CHP (Cooling, Heating and Power) System.**

**EXHAUST-ENERGY RECOVERY** CHPH Series Exhaust Gas Driven Absorption Machine produces both of cooling & heating directly from exhaust gas from engine or turbine without additional heat recovery systems

**EXCELLENT PART LOAD PERFORMANCE** Unit controller allows stable, part load operation at cooling water temperatures as low as 20°C (68°F) without a cooling water bypass. For maximum efficiency, a variable frequency drive pump automatically maintains optimum solution flow to Low-Temp Generator and also High-Temp Generator during whole operation.

**SIMPLE CONNECTION** Unit-mounted electrical items are factory-wired to the chiller microprocessor control panel. Only a single-point electrical connection to the chiller from the building's electrical service is required. A multi-tap transformer, mounted in the chiller control panel, provides secondary, single-phase power for the machine controls.

**LOW NOISE & VIBRATION** The overall sound level of the machine is less than 75dBA from 1 meter distance from the machine. This allows the machines to be installed near occupies spaces or in areas with strict sound requirements. Low vibration levels also make it possible to install the chiller on upper floors without special consideration for vibration dampening systems.

**COST-EFFECTIVE COOLING AND HEATING** The Machine is designed to have double-effect cycle providing more efficient usage of the same energy input. The Machine operates with the waste energy from exhaust gas and generates cooling and heating energy. Cooling operation produces chilled water, while heating operation produces hot water up to 60°C (140°F) as a standard and 79°C (175°F) as an option. Utilizing exhaust gas, full load cooling operation results in a Machine COP (coefficient of performance) of 1.3 at standard ARI operating conditions.



3,516kW Capacity / Gas Engine Exhausted Driven (Australia)

**PRECISE & OPTIMIZED OPERATION** Factory mounted, wired and tested microprocessor-based controller monitors and controls the machine operation continuously and automatically. A touch screen display identifies operational status and fault indication. All components meet internally acceptable codes like UL or CE or KS or the equivalents.

During the start-up sequence, the controller initiates a self-diagnostic system check to verify that all sensors are in range. Remote start/stop switch and a key-locked control panel door that protects against unauthorized access.

**RELIABILITY & EASY MAINTENANCE** Hermetical designed refrigerant and solution pumps which are only moving parts provide reliability and they are field serviceable through pumps isolation valves. Also marine-type water box cover on both of the absorber and condenser allows easy tube-cleaning and water-box-inspection.

And factory performance test, which is provided as an optional basis, ensure the performance and function of chiller before shipment.



Test of Absorption Chiller

**UNIFORM DISTRIBUTION OF REFRIGERANT & SOLUTION** The refrigerant and solution distribution system in evaporator and absorber is performed based on gravity and siphon phenomenon. This gravitational dropping distribution system adopts stainless steel tray and allows uniform solution spray and continuous heat transfer. Different from nozzle spray type of distribution system, this system eliminates an external pump to spray the solutions with nozzles and prevents nozzles from clogging.

**ANTI-CRYSTALLIZATION CONTROLS PROPER SOLUTION CONCENTRATION** Solution concentration is limited in several ways to avoid both of crystallization and over-dilution, providing dependable, trouble-free operation. The concentration control system automatically monitors the refrigerant water level in the evaporator in conjunction with the solution temperature returning to the absorber.

The Machine also incorporates a simple, passive method of control to correct any crystallization that would typically start to occur on the shell side of the low temperature solution heat exchanger under abnormal conditions.

**RELIABLE PURGE SYSTEM** Non-condensable gases are periodically exhausted from the storage tank by a simple procedure performed while the machine is running. Evacuation is performed by a unit-mounted vacuum pump that is connected to the purge evacuation valve.

# Absorption Cycle

## Cooling Cycle (Cooling Mode)

The double-effect, exhaust-fired absorption machine consists of an evaporator, absorber, condenser, high-temperature and low-temperature generators, solution heat exchangers, refrigerant and solution pumps, purge system, controls and accessories. During the cooling mode, the machine operates at the condition that under vacuum, water boils at a low temperature. Under typical operating conditions, this occurs at approximately 4.4°C (40°F), thereby cooling the chilled water that circulates through the evaporator tubes. A refrigerant pump is used to spray the refrigerant (water) over the evaporator tubes to improve heat transfer.

To make the cooling process continuous, the refrigerant (water) vapor must be removed as it is produced. To accomplish this, a lithium bromide solution (which has a high affinity for water) is used to absorb the water vapor. As this process continues, the lithium bromide becomes diluted, reducing its absorption capacity. A solution pump then transfers this diluted solution to the generators where it is re-concentrated in two stages (double-effect) to boil off the previously absorbed water. A variable frequency drive on the solution pump automatically maintains optimum solution flow to the generators at all operating conditions for maximum efficiency. The diluted solution is pumped to the high-temperature generator where it is heated and re-concentrated to a medium concentration solution by the exhaust heat from the turbine or engine exhaust gas. The medium concentration solution from the high-temperature generator flows to the low-temperature generator where it is heated and re-concentrated to a strong solution by

the high temperature water vapor released from the solution in the high-temperature generator. Since the low-stage generator acts as the condenser for the high-stage generator, the heat energy first applied in the high-stage generator is used again in the low-stage generator, thus reducing the heat input by approximately 45% as compared to an absorption chiller with a single-stage of re-concentration. The water vapor released in the shell side of the low-stage generator, in addition to the now condensed water vapor from the tube side of the low-stage generator, enters the condenser to be cooled and returned to a liquid state. The refrigerant water then returns to the evaporator to begin a new cycle.

To remove heat from the machine, cooling water from a cooling tower is first circulated through the tubes of the absorber to remove the heat of vaporization. The water is then circulated through the tubes of the condenser. The re-concentrated (strong) solution from the low-stage generator flows back to the absorber to begin a new cycle.

For efficiency purposes, the medium concentration solution from the high-stage generator is passed through the high-temperature solution heat exchanger to pre-heat the diluted (weak) solution, while pre-cooling the medium concentration solution. The re-concentrated (strong) solution from the low-stage generator is passed through the low-temperature solution heat exchanger to pre-heat/pre-cool the solution before being returned to the absorber.

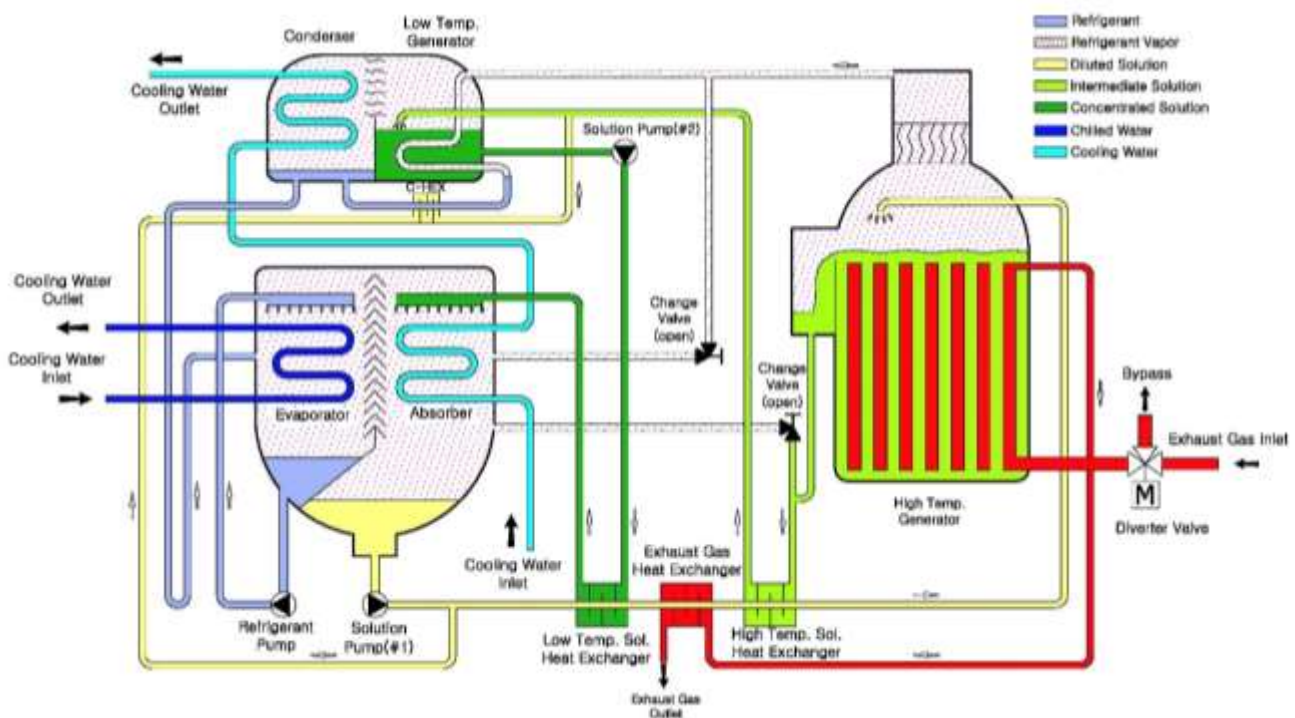

## Heating Cycle (Heating Mode)

During the heating mode, the cycle follows a different vapor flow path than that undertaken for cooling and does not use the typical absorption process. In addition, the absorber-condenser cooling water circuit is drained and thus not operated, since all heat rejection from the machine is designed to take place through the evaporator (now the heating bundle) in a classic two-pipe system that utilizes only the evaporator nozzles.

High temperature water vapor produced in the high-temperature generator section is passed directly to the evaporator via the absorber where it condenses and transfers its heat to the water circulating through the evaporator tubes.

This condensed water then flows to the absorber section where it mixes with the concentrated solution returning from the high-temperature generator. The diluted solution is then pumped back to the high-temperature generator to repeat the vapor generation phase for the heating function. Quick changeover from cooling to heating is accomplished by switching the positions of two hand valves, draining the absorber-condenser water circuit and putting the machine into heating mode by changing the position of a switch in the control panel.

The hot water temperatures is 60°C (140°F) as a standard without additional components and 79°C (175°F) as an option with the additional heat exchanger.

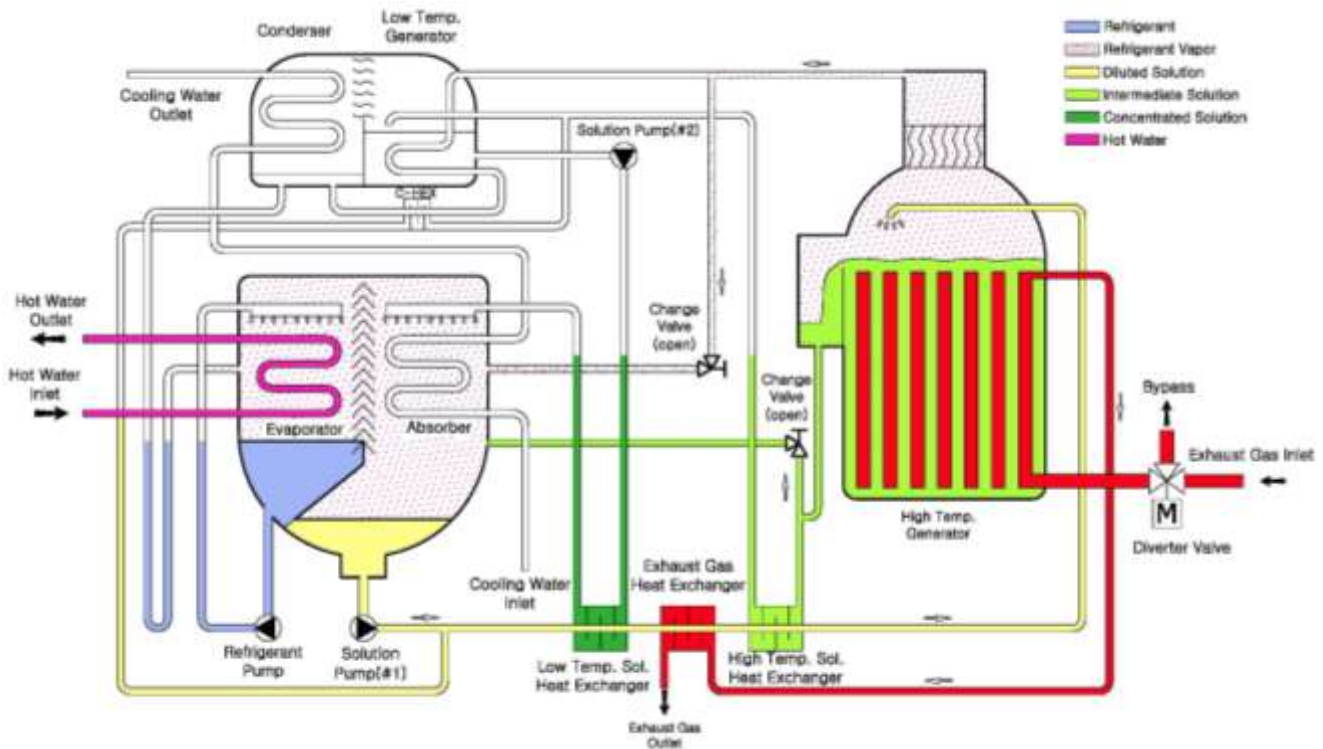

# Components Arrangement

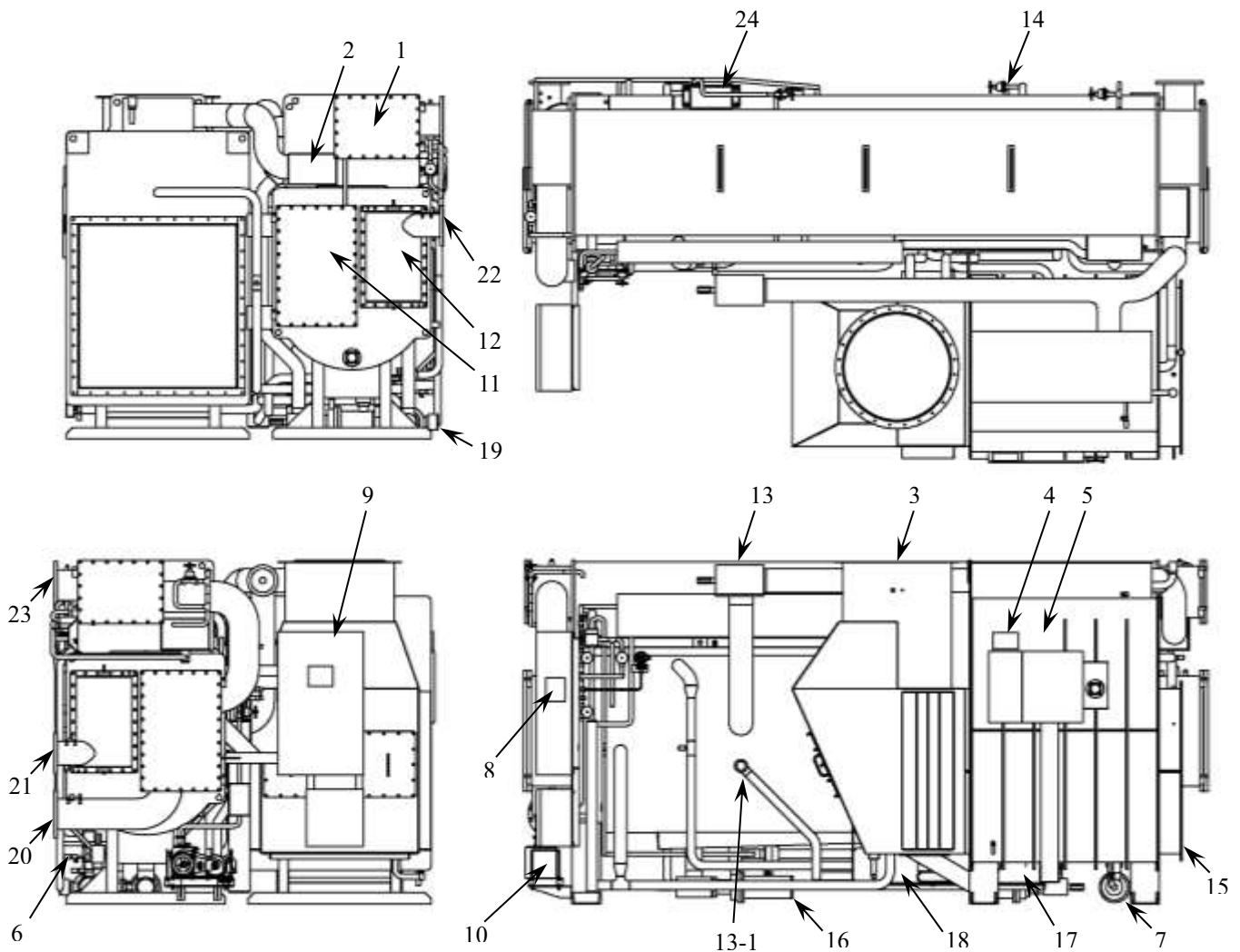

- |                              |   |
|------------------------------|---|
| 1. Condenser                 | 14. Blow Down Valve                         |
| 2. Low Temp. Generator (G2)  | 15. Exhaust Gas Inlet                       |
| 3. Exhaust Gas Outlet        | 16. Solution Pump(#1)                       |
| 4. G1 Level Control Box      | 17. High-Temperature Heat Exchanger (H1)    |
| 5. High temp. Generator (G1) | 18. Low-Temperature Heat Exchanger (H2)     |
| 6. Service Valve             | 19. Refrigerant Pump                        |
| 7. Solution Pump(#2)         | 20. Cooling Water Inlet                     |
| 8. Name Plate                | 21. Chilled Water Inlet                     |
| 9. Control Panel             | 22. Chilled Water Outlet                    |
| 10. Purge Pump               | 23. Cooling Water Outlet                    |
| 11. Absorber                 | 24. Condensation Refrigerant Heat Exchanger |
| 12. Evaporator               |   |
| 13. Changeover Valve_A       |   |
| 13-1. Changeover Valve_B     |   |

# Product Specification

**Electronically controlled CHPH Series Absorption Machine completely factory-packaged including evaporator, absorber, condenser, hermetic refrigerant pump & solution pump(#1,#2), vacuum pump, unit control panel, 1<sup>st</sup> generator, 2<sup>nd</sup> generator, low temperature heat exchanger, high temperature heat exchanger, Condensation refrigerant heat exchanger, and all inter-connecting piping and wiring. 3-way exhaust gas diverter valve is delivered loose for site installation, and initial charge of absorbent(lithium bromide) and refrigerant(distilled water) is supplied with factory charged or separate-packaged for on-site charging.**

## EVAPORATOR

consists of a shell & tube heat-exchanger with Nozzle-in-head (NIH) type water boxes. And for a uniform and continuous distribution of refrigerant, non-clogging designed stainless steel tray is adopted.

The inside of water boxes is epoxy coated before the shipment. Each inlet and outlet is equipped with 150psig flanged connection, PT 1/2" of drain nozzle and temperature sensor hole.

The heat-exchangers are inclusive of gaskets fitted on each header. The tubes are made of copper and are of notched floral type to increase the heat-transfer efficiency. All tubes are individually replaceable and straightly expanded on steel plates without welding. The standard outer diameter and thickness of the tubes are respectively 16 and 0.75 mm.

## ABSORBER

consists of a shell & tube heat-exchanger with marine type hinged water boxes that can be opened from both sides of the chiller for easy inspection and maintenance. And for a uniform and continuous distribution of solutions, non-clogging designed stainless steel tray is adopted.

The inside of water boxes is epoxy coated before the shipment. Each inlet and outlet is equipped with 150psig flanged connection, PT 1/2" of drain nozzle and temperature sensor hole.

The heat-exchangers are inclusive of gaskets fitted on each header. The tubes are made of copper and are of floral type to increase the heat-transfer efficiency. All tubes are individually replaceable and straightly expanded on steel plates without welding. The standard outer diameter and thickness of the tubes are respectively 16 and 0.6 mm.



Tray Performance Test

## CONDENSER

consists of a shell & tube heat-exchanger with marine type hinged water boxes that can be opened from both sides of the chiller for easy inspection and maintenance.

The inside of water boxes is epoxy coated before the shipment. Each inlet and outlet is equipped with 150psig flanged connection, PT 1/2" of drain nozzle and temperature sensor hole.

The heat-exchangers are inclusive of gaskets fitted on each header. The tubes are made of copper and are of prime type to increase the heat-transfer efficiency. All tubes are individually replaceable and straightly expanded on steel plates without welding. The standard outer diameter and thickness of the tubes are respectively 16~25 and 0.5~0.7 mm.

## 1<sup>ST</sup> GENERATOR (HIGH TEMP. GENERATOR)

consists of a liquid tube type heat-exchanger. The tubes are made of carbon steel pipe and are of high finned & prime type to increase the heat-transfer efficiency. The standard outer diameter and thickness of the tubes are respectively 48.60 and 3.70 mm. The generator is supplied with level relays to constantly check the level of the absorbent solution and fusible plug as safety device.

And for a connection with exhaust gas supply, a flanged inlet connection is furnished and inspection door is furnished for an inspection of inside of 1st generator.

## 2<sup>ND</sup> GENERATOR (LOW TEMP. GENERATOR)

consists of a shell & tube heat-exchanger with welded headers. The tubes are made of copper and are of low finned type to increase the heat-transfer efficiency. The standard outer diameter and thickness of the tubes are respectively 19.05 and 1.30 mm. (0.75 and 0.05 inch)

## LT & HT SOLUTION HEAT EXCHANGERS

HIGH COP chiller is equipped with welding type higher efficiency plate heat-exchangers. Plates are made of stainless steel.

## CONDENSATION REFRIGERANT HEAT EXCHANGER

is located between 2<sup>nd</sup> generator and condenser to recover more heat from the high temperature condensed refrigerant in 2<sup>nd</sup> generator. It consists of brazed type high efficiency plate heat-exchangers and are of stainless steel.

## EXHAUST GAS HEAT EXCHANGER

is connected to exhaust gas outlet of 1<sup>st</sup> generator to recover heat from the exhaust gas and heat up the diluted solution from LT solution heat exchanger. It is liquid tube type heat-exchangers and the tubes are made of carbon steel pipe and are of high finned type to increase the heat-transfer efficiency. The outer diameter and thickness of the tubes are respectively 48.60 and 3.70 mm. (1.91 and 0.16 inch)

## ABSORBENT SOLUTION SAMPLING VALVES

are installed on the HT and LT solution heat exchangers.

## Product Specification(Cont)

### SOLUTION PUMPS

worldenergy chillers are equipped with VVVF inverter driven solution pump to control the diluted solution flow. And HIGH COP chiller is equipped with 1(one) more solution pump for the control of concentrated solution flow from 2<sup>nd</sup> generator to the LT heat exchanger. All pumps are low-power consumed, self-contained, leak-proof, hermetic motor driven canned type pumps cooled by the same pumped fluid. The pumps are factory fitted with isolating valves on both suction and discharge sides to avoid the drainage of the solution in case of pump repair or maintenance. 20,000 hours of normal operation is guaranteed.



Canned type pump & Isolating Valves (Angle valves)

### REFRIGERANT PUMPS

Low-power consumed, self-contained, leak-proof, hermetic motor driven canned type pumps cooled by the same pumped fluid. The pumps are factory fitted with isolating valves on both suction and discharge sides to avoid the drainage of the solution in case of pump repair or maintenance. 20,000 hours of normal operation is guaranteed

### VACUUM PUMP

is equipped with belt-driven electrical motor. The pump is oil-lubricated and inclusive of oil level sight glass. First oil charge is included. The pump is also composed of air-intake valve for oil moisture removal and liquid trap on the suction line. The vacuum circuit is also composed of non-condensable gases storage tank, Ejector Device, pump liquid trap, diaphragm valves, vacuum Hg manometer, piping and service valve.

### DIFFERENTIAL PRESSURE SWITCH

Chilled water differential pressure switch(or flow switch) shall be factory installed in the evaporator water nozzle chilled water flow detection. Cooling water flow switch shall be field installed or factory installed if customer requires and supplied by either the chiller manufacturer or the contractor/owner. And final adjustment must be done during the commissioning.

### EXHAUST GAS DIVERTER VALVE

is 3-way type and supplied loose with the chiller and is used to control the ingress of the exhaust gases into the 1st Generator of the chiller based on the cooling demand of the user. The Diverter Valve could modulate from 0 to 100% thanks to the signal received by the electrical actuator (supplied with the diverter) from the chiller's microprocessor. The Diverter Valve has also a safety function with a spring return that shuts the valve in case of a power failure. The scope of supply of the valves include an electrically-driven air seal blower that injects air inside the valve when the chiller does not need exhaust gas in order to prevent exhaust gas infiltrations inside the chiller in case of possible diverter valve leakages.

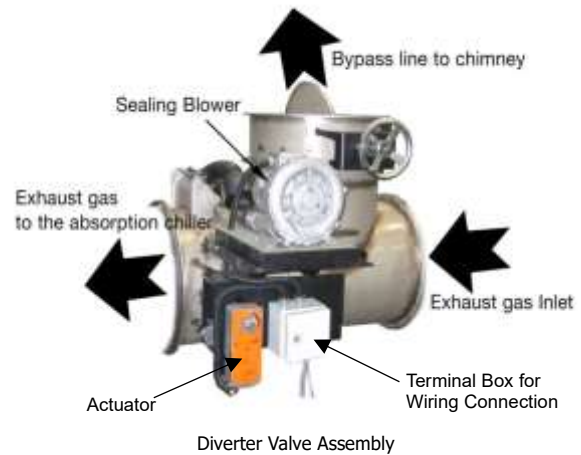

### PURGE SYSTEM

An automatic purge system shall be provided to provide a continuous purging action whenever the chiller is in operation to assure long machine life and efficient performance. Non-condensable gas shall be removed from the absorber by a liquid eductor, which shall use flow from solution pump to create a suction. Non-condensable gas shall be stored external to the unit and shall be prevented from diffusing back into the machine when the unit is not operating. Evacuation of the external storage tank shall be accomplished by the use of a unit-mounted vacuum pump. The vacuum pump shall be factory mounted on the chiller and wired to the control panel by the chiller manufacturer.

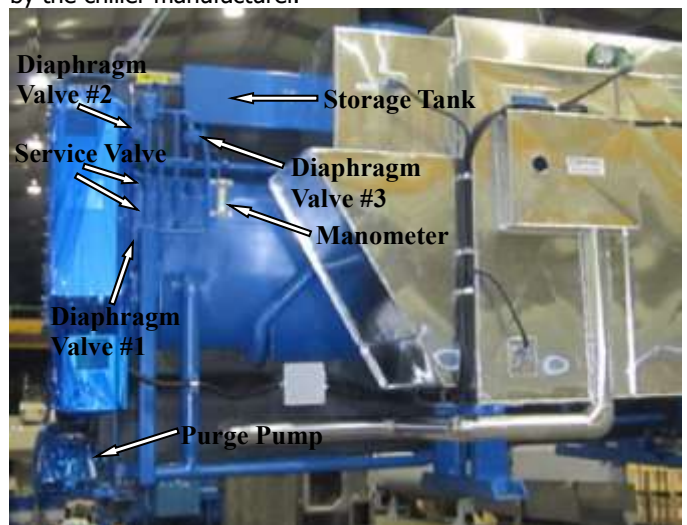

Purging Unit

### TEMPERATURE SENSORS

3(three) types of temperatures are used depending on the temperature levels: RTD\_Low, RTD\_Medium, RTD\_High

- Chilled water inlet & outlet temperature (RTD\_Low)
- Cooling water inlet & outlet temperature (RTD\_Low)
- Evaporator refrigerant outlet temperature (RTD\_Low)
- Condenser refrigerant outlet temperature (RTD\_Low)
- LT generator solution temperature (RTD\_Low)
- HT generator solution temperature (RTD\_Medium)
- Driving exhaust gas inlet temperature (RTD\_High)
- Exhaust gas outlet temperature (RTD\_High)



# Product Specification(Cont)

## REFRIGERANT & ABSORBENT SOLUTION

The chiller is delivered together with lithium bromide solution(55wt% concentration) added with 300 ppm lithium molybdate as a corrosion inhibitor, demineralized water as a refrigerant and N-Octyl Alcohol(CH<sub>3</sub>(CH<sub>2</sub>)<sub>7</sub>OH) which will reduce surface tension and increase heat transfer. The refrigerant and absorbent solution is factory charged or supplied in 200liters plastic drums.

## SIGHT GLASSES

Total 4(four) sight glasses are installed. One is installed on Evaporator to monitor refrigerant level and the other 2(two) are installed on Absorber and 1<sup>st</sup> generator to monitor solution levels.

## DAMPERS

Total 3(three) dampers are provided for refrigerant and solution flow tuning at site. Different from STNADARD COP model, HIGH COP model 1(one) more damper is provided between concentrated heat exchanger and diluted discharge of diluted solution pump.

## CHECK VALVES & SERVICE VALVES

are installed for service purpose such as solution sampling and etc.

## QUALITY ASSURANCE

The chiller is designed and manufactured according to following codes:

- ARI Standard 560 (latest edition).
- ANSI/ASHRAE 15(latest edition)
- KS B 6271 (Korea Standard)
- JIS 8622 (Japanese Standard)
- UL (if required)
- CE/PED (if required)
  - 2006/42/EC (Machinery directive)
  - 2006/95/EC (Low Voltage directive)
  - 2004/108/EC (Electromagnetic Compatibility directive)
  - 97/23/EC (Pressure Equipment directive)

Each chiller shall undergo a series of standard factory tests to ensure that the unit is leak tight, that all electrical components operate as intended, and that every aspect of the unit fabrication meets stringent quality standards in accordance with good practice and the manufacturer's quality assurance requirements.

The shell side of each chiller shall be leak tested by pressurizing to 76kPa (11 psig) with nitrogen and then checked by spraying a soap/water mixture on all welds, tube joints, and/or gasket joints to identify any major leaks. Afterward, a mass spectrometer test shall be performed by evacuating the unit to 0.001mmHg absolute, covering the machine with a vinyl tent, and introducing helium gas under the tent. Any remaining leaks will allow the helium to be drawn into the shell side of the machine. The acceptable leak rate as measured by the mass spectrometer test shall not exceed 0.00001 cc/sec standard air.

The tube side of the evaporator, absorber, and condenser shall be hydrostatically tested at 1.5 times rated design pressure and held for one hour.

The refrigerant and solution pump/motors shall undergo standard factory tests to ensure proper head flow, and motor output characteristics.

All machine wiring shall undergo an insulation resistance test. The chiller control center and all electrical components shall also be

functionally tested to verify continuity and proper electrical operation.

Final assembly inspection shall consist of verifying that all valves, controls, instrumentation, pumps, purge components, and all other machine components have been properly installed on the machine.

Each unit shall then be checked for overall appearance and dimensional accuracy.

Final inspection shall be performed on each unit to check that painting of the unit is as specified, name-plate data is correct, and that all accessories are furnished as required.

## PRE-SHIPMENT FACTORY TEST

Leakage test with He(Helium) & N<sub>2</sub>(Nitrogen)  
Hydraulic test  
Electrical function test  
Nitrogen gas charging

## MACHINE SAFETY DEVICES

Machine safety and limit devices shall be included as follows:  
Chilled water temperature  
Chilled water flow  
Cooling water flow (optional)  
Fusible plug  
HT Generator temperature  
HT Generator pressure  
Motor winding temperature (refrigerant / solution pumps)  
Motor amperage (refrigerant / solution pumps)

## ELECTRICAL REQUIREMENTS

Power supply to the unit shall be 3-ph, 60Hz with voltages of 380V, 400V, 440V, 460V or, 3-ph, 50Hz with 380V, 400V, 440V or 460V as specified on the equipment schedule. A multi-tap transformer shall provide single-phase and 24 DC secondary power for the control panel

Contractor shall supply and install the electrical power line and all auxiliary electrical protection devices per local code requirements and as indicated necessary by the chiller manufacturer.

## POWER CONNCTION

A single point power connection is all that is required.

## PIPING REQUIREMENTS

Piping and instrumentation for the chilled(hot) water, cooling water, driving exhaust gas inlet, chiller exhaust gas outlet, diverter connection, water discharge connections shall be supplied and installed by the contractor / owner.

## SOUND LEVEL

The overall sound pressure level of the chiller shall not exceed 75dba when measured per ARI Standard 575 (latest edition).

## STANDARD SPARES

The following spares shall be delivered:  
Fuses  
Purge pump oils (2 Liters)  
Touch-up paint (2 Liters)

# Product Specification(Cont)

## THERMAL INSULATION (OPTION)

is provided optionally and shall be done with following materials:

Hot Surfaces : Non-inflammable polymer sponge for high temp. usable up to max. 120°C (248 °F)



Glass wool & Galvanized steel for high temperature generator

Cold Surfaces: Non inflammable polymer sponge.

## START-UP (OPTION)

shall be performed and/or supervised with separate contract with the client.

## OPTIONS

Item	Available
Special application design	Anti-freeze media on water circuits Low chilled water design (min. 4°C) Explosion-proof design Chemical plant heat recovery Outdoor installation design Marine application design
Certifications	CE, ISO(kmAR)
Water circuit connections	Flanged with ANSI or DIN or KS Victaulic connection
High pressure Water box	16bar(250psig), 20bar(300psi)
Special tubing	Non-standard tube thickness, Material change (CuNi, Titanium)
BMS interface	MODBUS-RTU, MODBUS-TCP/IP PROFIBUS, BACnet, INTERNET
Remote monitoring & control s/w	
Cooling water flow detection	Differential pressure switch, Flow switch
Outdoor installation and/or Anti-freeze design	Enclosure IP55 control cabinet Trace heater on Evaporator 
Purge line back flow prevention valve	Solenoid valve on purge pump 
Control valve	Pneumatic * Motorized control valve
Safety device	Rupture disc for high temperature generator
Packing	Wooden boxing * Plastic cover packing is standard
Others	Foundation anchoring packages Vibration isolation package Sectional shipment (2~3 pieces) Warranty extension Installation supervision Commissioning & start-up

# Performance Data(Cont)

CHP005HH~CHP021HH

Model		unit	CHP005 HH	CHP006 HH	CHP007 HH	CHP008 HH	CHP010 HH	CHP012 HH	CHP015 HH	CHP018 HH	CHP021 HH
Cooling Capacity		usRT	50	60	70	80	100	120	150	180	210
		kW	176	211	246	281	352	422	527	633	738
Chilled Water	Inlet → Outlet Temp	°C	12 → 7								
	Flow rate	m <sup>3</sup> /h	30.2	36.3	42.3	48.4	60.5	72.6	90.7	108.9	127.0
	Pressure Drop	mH <sub>2</sub> O	7.5	6.9	6.3	6.9	5.9	6.1	8.0	8.2	7.6
	Connection	mm	80				100				125
Cooling Water	Inlet → Outlet Temp	°C	32 → 37.1								
	Flow rate	m <sup>3</sup> /h	50	60	70	80	100	120	150	180	210
	Pressure Drop	mAq	7.3	6.1	8.0	7.6	7.3	7.7	9.9	10.4	11.5
	Connection	mm	100				125		150		
Heating Capacity		Mcal/ h	103	123	144	165	206	247	309	370	432
		kW	120	143	167	191	239	287	359	430	502
Hot Water	Inlet → Outlet Temp	°C	56.6 → 60								
	Flow rate	m <sup>3</sup> /h	30.2	36.3	42.3	48.4	60.5	72.6	90.7	108.9	127.0
	Pressure Drop	mH <sub>2</sub> O	7.5	6.9	6.3	6.9	5.9	6.1	8.0	8.2	7.6
	Connection	mm	80				100				125
Exhaust Gas	Gas Flow rate	kg/se c	0.305	0.366	0.427	0.488	0.610	0.732	0.915	1.098	1.281
	Inlet → Outlet Temp @ Cooling	°C	450 → 120								
	Inlet → Outlet Temp @ Heating	°C	450 → 125								
	Pressure Drop	mmH <sub>2</sub> O	48	53	66	69	58	99	69	95	88
	Inlet Connection	mm* mm	782*291	782*330	782*369	782*408	922*408	922*486	922*603	922*642	922*681
	Outlet Connection	mm	300				400				500
	Diverter Valve	mm	300				400				500
Electric	Power source		3φ 400V (50Hz)								
	Refrigerant Pump	kW	0.2(1.2)								0.3(1.4)
	Absorbent Pump 1	kW	1.2(3.8)				1.5(4.8)				2.0(5.7)
	Purge Pump	kW	0.4(1.4)								
	Sealing Blower	kW	0.75(2.4)				1.5(3.4)				
	Control Panel	kW	0.2 (0.5)								
	Total kW	kW	2.8				3.8				4.4
	Total Ampere@400V	A	9.3				11.3				12.4
Externa l Dimens ion	Length (L)	mm	2110		2610		2658		3678		3728
	Width (W)	mm	1683	1722	1761	1800	1857	1935	1965	1984	2194
	Height (H)	mm	2017				2202				2460
Weight	Rigging	Ton	3.0	3.2	3.7	3.9	5.0	5.3	6.4	6.8	7.9
	Operation	Ton	3.2	3.5	4.0	4.3	5.4	5.8	7.0	7.4	8.6
Space tube Replacement	mm	1,900		2,400	2,400	2,400	2,400	3,400	3,400	3,400	

# Performance Data(Cont)

CHP024HH~CHP063HH

Model		unit	CHP024 HH	CHP028 HH	CHP032 HH	CHP036 HH	CHP040 HH	CHP045 HH	CHP050 HH	CHP056 HH	CHP063 HH
Cooling Capacity		usRT	240	280	320	360	400	450	500	560	630
		kW	844	985	1,125	1,266	1,407	1,582	1,758	1,969	2,215
Chilled Water	Inlet → Outlet Temp	℃	12 → 7								
	Flow rate	m <sup>3</sup> /h	145.2	169.3	193.5	217.7	241.9	272.2	302.4	338.7	381.0
	Pressure Drop	mH <sub>2</sub> O	7.5	5.4	5.3	5.7	5.8	5.0	5.3	7.3	9.9
	Connection	mm	125	150				200			
Cooling Water	Inlet → Outlet Temp	℃	32 → 37.1								
	Flow rate	m <sup>3</sup> /h	240	280	320	360	400	450	500	560	630
	Pressure Drop	mAq	10.2	8.3	7.9	8.1	8.2	8.2	8.3	11.3	15.3
	Connection	mm	150	200				250		300	
Heating Capacity		Mcal/h	494	576	658	741	823	926	1,029	1,152	1,296
		kW	574	669	765	861	956	1,076	1,195	1,339	1,506
Hot Water	Inlet → Outlet Temp	℃	56.6 → 60								
	Flow rate	m <sup>3</sup> /h	145.2	169.3	193.5	217.7	241.9	272.2	302.4	338.7	381.0
	Pressure Drop	mH <sub>2</sub> O	7.5	5.4	5.3	5.7	5.8	5.0	5.3	7.3	9.9
	Connection	mm	125	150				200			
Exhaust Gas	Gas Flow rate	kg/se c	1.464	1.708	1.952	2.195	2.439	2.744	3.049	3.415	3.842
	Inlet → Outlet Temp @ Cooling	℃	450 → 120								
	Inlet → Outlet Temp @ Heating	℃	450 → 125								
	Pressure Drop	mmH <sub>2</sub> O	109	117	145	101	129	135	135	106	103
	Inlet Connection	mm* mm	922*681	922*798	922*876	1376*720	1376*759	1376*837	1376*915	1376*1008	1376*1143
	Outlet Connection	mm				600				750	
	Diverter Valve	mm				600				750	
Electric	Power source		3φ 400V (50Hz)								
	Refrigerant Pump	kW	0.3(1.4)				0.4(1.4)				
	Absorbent Pump 1	kW	2.0(5.7)			2.4(6.7)		3.0(8.6)			
	Purge Pump	kW	0.4(1.4)								
	Sealing Blower	kW	1.5(3.4)							2.2(5.1)	
	Control Panel	kW	0.2 (0.5)								
	Total kW	kW	4.4			4.8		5.5		6.2	
	Total Ampere@400V	A	12.4			13.4		15.3		17.0	
External Dimension	Length (L)	mm	3728	4748		4854		4872		5414	5912
	Width (W)	mm	2194	2310		2349		2514	2592	2646	2781
	Height (H)	mm	2460			2557		2717			
Weight	Rigging	Ton	8.5	9.8	10.3	12.8	13.2	15.7	16.5	21.2	23.1
	Operation	Ton	9.3	10.7	11.3	14.0	14.6	17.2	18.1	23.7	25.8
Space tube Replacement	mm	3,400	4,600						5,200		5,700

# Performance Data(Cont)

## CHP070HH~CHP150HH

Model		unit	CHP07 0HH	CHP07 7HH	CHP08 4HH	CHP09 0HH	CHP10 0HH	CHP11 0HH	CHP12 0HH	CHP13 0HH	CHP14 0HH	CHP15 0HH		
Cooling Capacity		usRT	700	770	840	900	1000	1100	1200	1300	1400	1500		
		kW	2,461	2,708	2,954	3,165	3,516	3,868	4,220	4,571	4,923	5,274		
Chilled Water	Inlet → Outlet Temp	°C	12 → 7											
	Flow rate	m <sup>3</sup> /h	423.4	465.7	508.0	544.3	604.8	665.3	725.8	786.2	846.7	907.2		
	Pressure Drop	mH <sub>2</sub> O	9.4	12.0	15.1	9.0	11.9	15.1	11.4	14.3	8.6	10.6		
	Connection	mm	200	250				300			350			
Coolin g Water	Inlet → Outlet Temp	°C	32 → 37.1											
	Flow rate	m <sup>3</sup> /h	700	770	840	900	1000	1100	1200	1300	1400	1500		
	Pressure Drop	mAq	11.9	13.4	14.0	8.8	14.8	15.8	14.1	13.4	13.6	14.1		
	Connection	mm	300	350				400						
Heating Capacity		Mcal/ h	1,440	1,584	1,728	1,851	2,057	2,263	2,469	2,674	2,880	3,086		
		kW	1,674	1,841	2,008	2,152	2,391	2,630	2,869	3,108	3,347	3,586		
Hot Water	Inlet → Outlet Temp	°C	56.6 → 60											
	Flow rate	m <sup>3</sup> /h	423.4	465.7	508.0	544.3	604.8	665.3	725.8	786.2	846.7	907.2		
	Pressure Drop	mH <sub>2</sub> O	9.4	12.0	15.1	9.0	11.9	15.1	11.4	14.3	8.6	10.6		
	Connection	mm	200	250				300			350			
Exhau st Gas	Gas Flow rate	kg/se c	4.269	4.696	5.123	5.489	6.099	6.708	7.318	7.928	8.538	9.148		
	Inlet → Outlet Temp @ Cooling	°C	450 → 120											
	Inlet → Outlet Temp @ Heating	°C	450 → 125											
	Pressure Drop	mmH <sub>2</sub> O	117	120	122	121	151	152	159	156	154	143		
	Inlet Connection	mm* mm	1376*1 233	1376*1 218	1376*1 368	1376*1 368	1376*1 418	1376*1 418	1376*1 518	1376*1 668	1376*1 818	1376*2 068		
	Outlet Connection	mm	750					1000						
	Diverter Valve	mm	750					1000						
Electri c	Power source		3φ 400V (50Hz)											
	Refrigerant Pump	kW	0.4(1.4)				1.5(4.0)				1.8(6.0)			
	Absorbent Pump 1	kW	4.5(12.4)				5.5(14.3)				4.5(15.2)		5.5(19.0)	
	Purge Pump	kW	0.4(1.4)						0.75(2.2)					
	Sealing Blower	kW	2.2(5.1)											
	Control Panel	kW	0.2 (0.5)											
	Total kW	kW	7.7				9.8			9.2		10.5		
	Total Ampere@400 V	A	20.8				25.3			27.0			32.8	
Extern al Dimen sion	Length (L)	mm	6012	6537	7037	6114	6639	7139	6749	7249	6966	7466		
	Width (W)	mm	3070	3261		3485	3535		4348	4498	4932	5182		
	Height (H)	mm	2963				3171			3500		3765		
Weight	Rigging	Ton	24.6	27.1	32.5	33.6	35.6	41.1	43.4	46.4	50.2	54.1		
	Operation	Ton	27.5	30.3	36.3	37.6	39.9	46.2	48.8	52.1	56.5	60.8		
Space tube Replacement		mm	5,700	6,300	6,700	5,700	6,300	6,700	6,300	6,700	6,300	6,700		

**Note**

1. Working pressure of each water sides are based on 1.0Mpa (150psig)
2. Fouling factor 0.0001 m<sup>2</sup>.hr.°C/Kcal for Absorber, Condenser and Evaporator.
3. Min. outlet temp. of chilled water: 41 °F
4. Min. allowable inlet temp. of cooling water: 68 °F
5. Controllable range shall be 0~100%.
6. Available power sources (options): 220V, 380V, 440V and 460V with 50HZ or 60HZ.
7. Custom designed is available with modifications from the standard or redesign
  - Cooling capacity
  - Chilled and Cooling water circuit with anti-freezing additives
  - Higher working pressure
  - Special tubes and thicker shell material
  - Various operational temp. conditions
  - Higher delta t operation
  - Outdoor installation
8. The specifications above are subject to change without prior notice for an improvement of the chiller.

# Control System

Unit Controller is factory mounted, wired and tested to ensure a protection of the Machine, and efficient capacity control. The program logic provides proper Start/Stop of the Machine and also enables a communication interface with BMS.

A programmable logic controller monitors and controls all operations of the machine. The programmable logic controller system matches the cooling capacity of the machine to the cooling load while providing state of machine protection.

The control system controls the operation of the machine by monitoring all operating conditions. The programmable logic controller panel can diagnose a problem and let the operator know what the problem is and what to check. It can interface with auxiliary equipment such as pumps and cooling tower fans. It continually checks all safeties to prevent any unsafe operating condition.

- » **Component test and diagnostic check**
- » **Menu-driven touch keypad interface for status Status display, set-point control and system configuration**
- » **Primary and secondary status messages**
- » **Password protected**
- » **Recall of up to 200 alarm and warning messages**
- » **Extensive diagnostic and service capabilities**
- » **Advanced crystallization preventive algorithm**
- » **Improved solution flow control**

## HARDWARE

- Programmable Logic controller
  - » SIEMENS PLC Controller
- Built-in Touch Screen LCD (7" Color)
- VVVF inverter with isolated cabinet
- IP52 Protection Grade Cabinets
- Step-down transformer
- Indication lamps for chiller & pumps status and alarm
- Selector Switch for purge pump operation, operation reset and emergency chiller stop
- Buzzer On/Off selector switch

## USER INTERFACE

- Interlock with Chilled(hot) water pump and cooling water pump
- Chiller Start/Stop and chilled water temp. setting
- Cooling tower Fan ON/OFF or speed control
- MODBUS, PROFIBUS, BACnet, INTERNET (Option)

## CAPACITY CONTROL

The cooling capacity is automatically controlled within the chilled (hot) water set point temperature plus the dead-band by sensing the leaving chilled water and regulating flow and direction of the driving exhaust gas via the diverter valve blades,

which are mechanically linked with actuator,

## REMOTE START/STOP CONTROL

A remote device, such as a time clock which uses a set of contacts, may be used to start and stop the chiller.

## COOLING TOWER-FAN RELAY

The cooling tower-fan relay can be controlled when cooling water inlet temperature is low. The temperature setting point is adjustable in the range 15 ~ 30°C(60 ~ 85°F).

## AUTO RESTART AFTER POWER FAILURE

If the control power is interrupted during operation, the chiller stops immediately without the normal shutdown sequence and dilution. Solution crystallization can occur if the concentration is high (chiller was operating with a relatively large load). The machine will start automatically when the power is back on.

## SPARE SAFETY INPUTS

Normally closed (NC) digital inputs for additional field-supplied safeties may be wired to the spare protective limits input channel in place of the factory-installed jumper. (Wire multiple inputs in series.) The opening of any contact will result in a safety shutdown and controller display.

## SAFETY CONTROL

The Control panel monitors all safety control inputs and if required shuts down the chiller or stops solution pump to protect the chiller from possible damage from any of the critical conditions. The controller screen displays the messages if the controller starts safety controls to stop, the alarm relay operates and alarm indicator is brink. The alarm is saved in the controller alarm table to correct the problems.



SIEMENS POL635 Controller



LCD Touch Screen



Control Panel

## Control System(Cont)

### SAFETY CUTOUPS

- Solution pump(s) motor OVERLOAD/ temp. HIGH
- Refrigerant pump motor OVERLOA/ temp. HIGH
- Low Chilled water outlet temperature cutout
- Low Chilled water flow cutout
- Low Evaporator refrigerant temperature cutout
- Low Cooling water inlet temperature cutout
- Low Cooling Water flow cutout (Option)
- High 1st generator solution outlet temperature cutout
- 1st generator pressure HIGH
- 1st generator solution level LOW
- High 2nd generator solution outlet temperature cutout
- High Exhaust gas inlet temperature cutout
- High Exhaust gas outlet temperature cutout
- Emergency Stop

### PROTECTIVE LIMITS

- Max. allowable cooling water inlet temperature
- Max. allowable 1st generator absorbent temperature
- Max. allowable exhaust inlet temperature
- Max. allowable absorbent concentration
- Low chilled water temperature

### TEMPERATURE SENSOR FAULTS

- Chilled water outlet temperature.
- Cooling water inlet temperature.
- Evaporator refrigerant temperature.
- Condenser refrigerant temperature.
- 1st generator solution outlet temperature.
- 2en generator solution outlet temperature.
- Exhaust gas inlet temperature.
- Exhaust gas outlet temperature.

### OPERATION STATUS DISPLAY

- Chilled water inlet & outlet temperature.
- Cooling water inlet & outlet temperature.
- Driving exhaust gas inlet & outlet temperature.
- 1st Generator temperature.
- 2nd Generator temperature.
- Condenser temperature.
- Evaporator temperature.
- Temperature setting
- Various status of chiller operation
- Status of diverter valve control mode
- Concentration percentage
- Opening percentage of the diverter valve
- Status of the chiller's auxiliaries
- User's auxiliaries status (if available from the user)
- Date and time
- Absorption chiller's dilution cycle at shutdown
- No. of operating hours
- No. of starts
- Alarm ranges settings
- Alarm data log
- Graphical display of chilled water temp. trend
- PID logic and other service-related parameters
- Operation Schedule
- Safety shutdown message
- Display language selection
- Diluted solution pump inverter frequency



# Communication

1. MODBUS-RTU

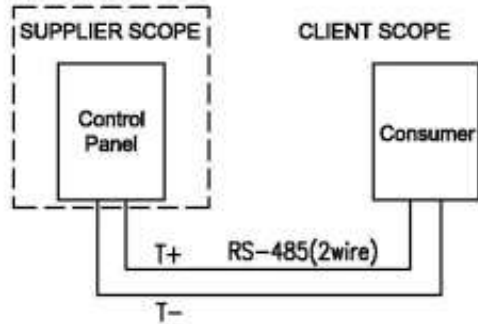

4. BACnet

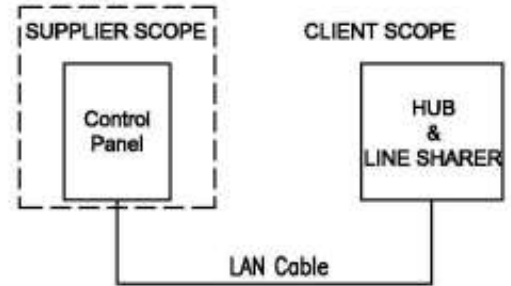

2. MODBUS-TCP

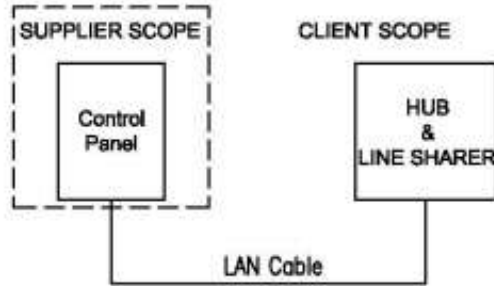

5. INTERNET KIT(PLC)

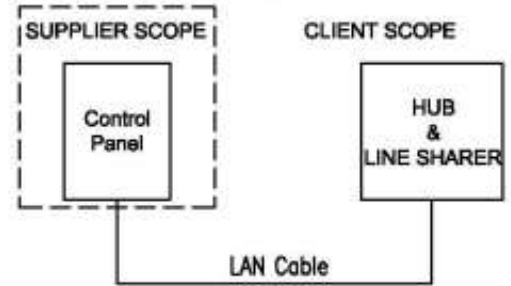

3. PROFIBUS

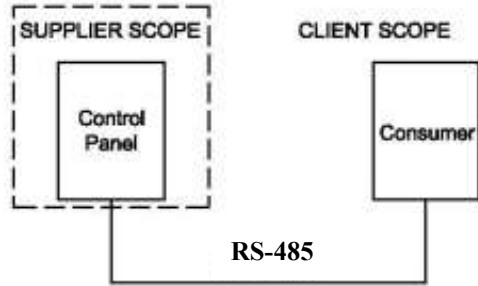

# Start-up Sequence

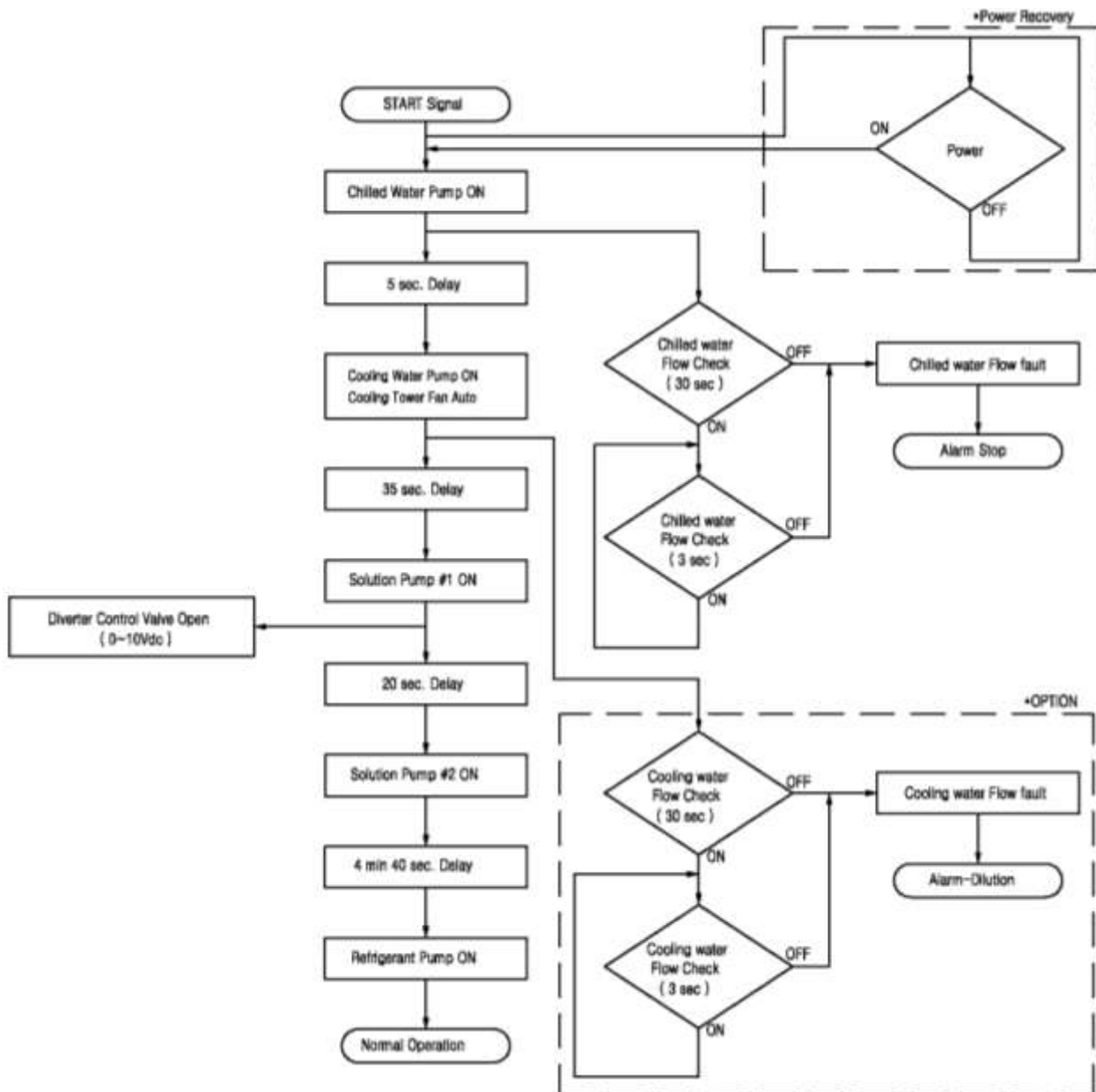

# Stop Sequence

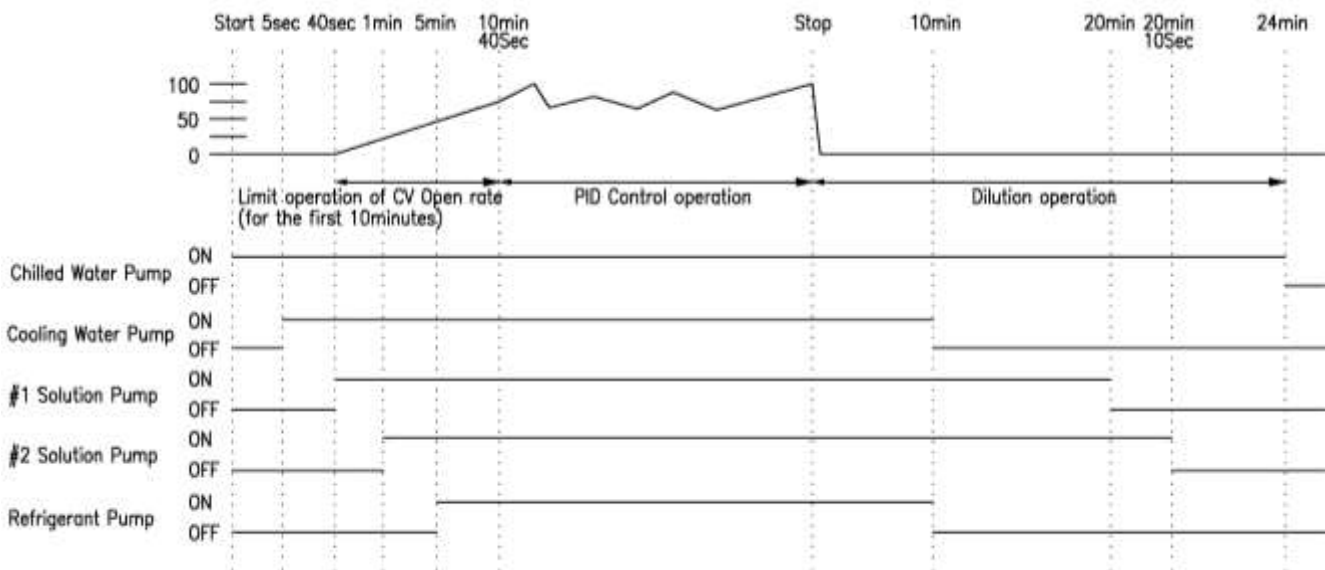
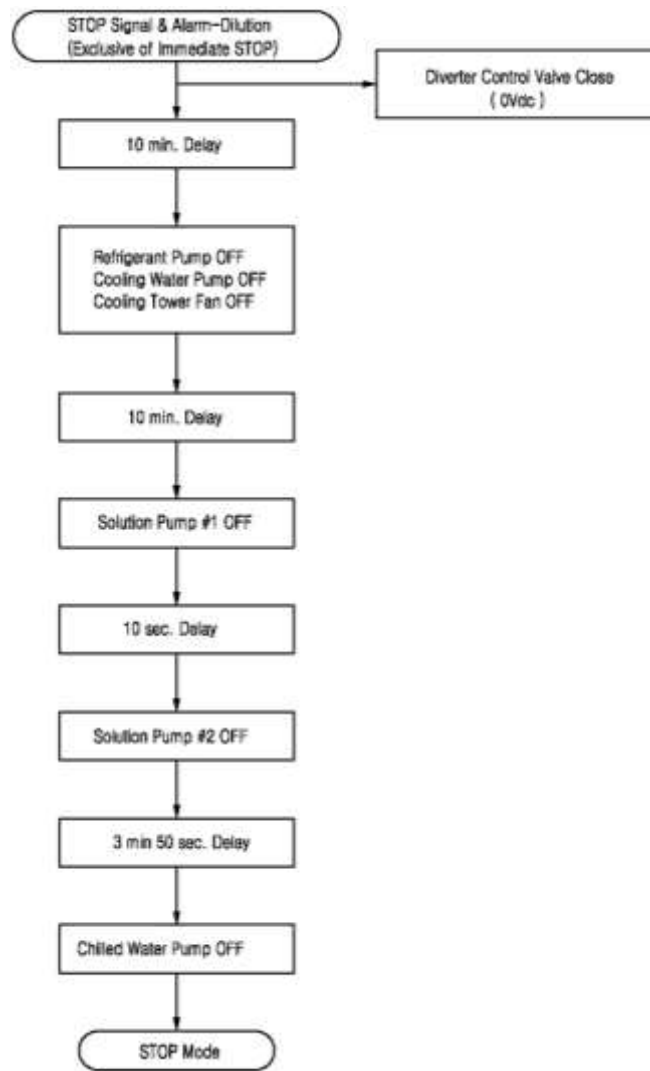

<Operation Graph>

# Control Panel

## >> Main Control panel Cabinet

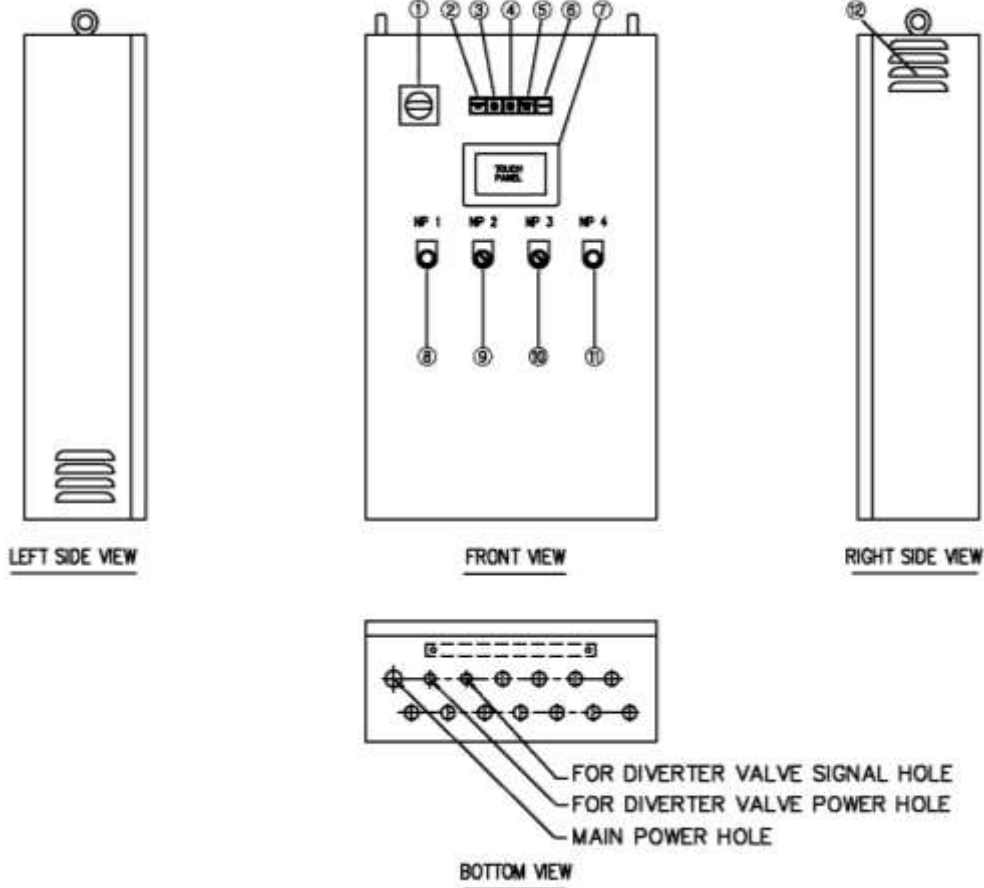

NO.	SYMBOL NAME	DESCRIPTION
1	Q1	DISCONNECT SWITCH
2	LT1	SYSTEM RUN LIGHT
3	LT4	SOLUTION PUMP LIGHT
4	LT3	REFRIGERANT PUMP LIGHT
5	LT5	PURGE PUMP LIGHT
6	LT2	TOTAL ALARM LIGHT
7	TOP	TOUCH OPERATION PANEL
8	BZ	BUZZER
9	S1	BUZZER ON/OFF SELECTOR SWITCH
10	S2	PURGE PUMP START/STOP SELECTOR SWITCH
11	S3	EMERGENCY STOP
12	CF	COOLING FAN

## >> Inverter panel Cabinet

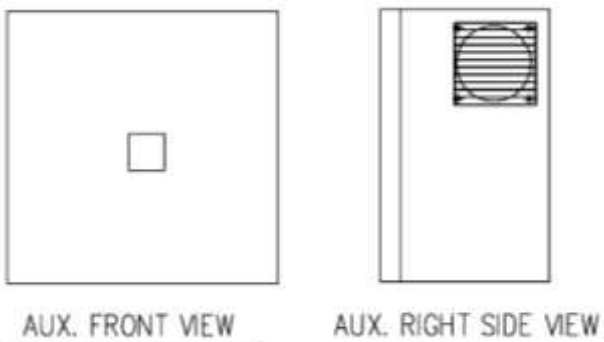

## Control Panel – Inside View

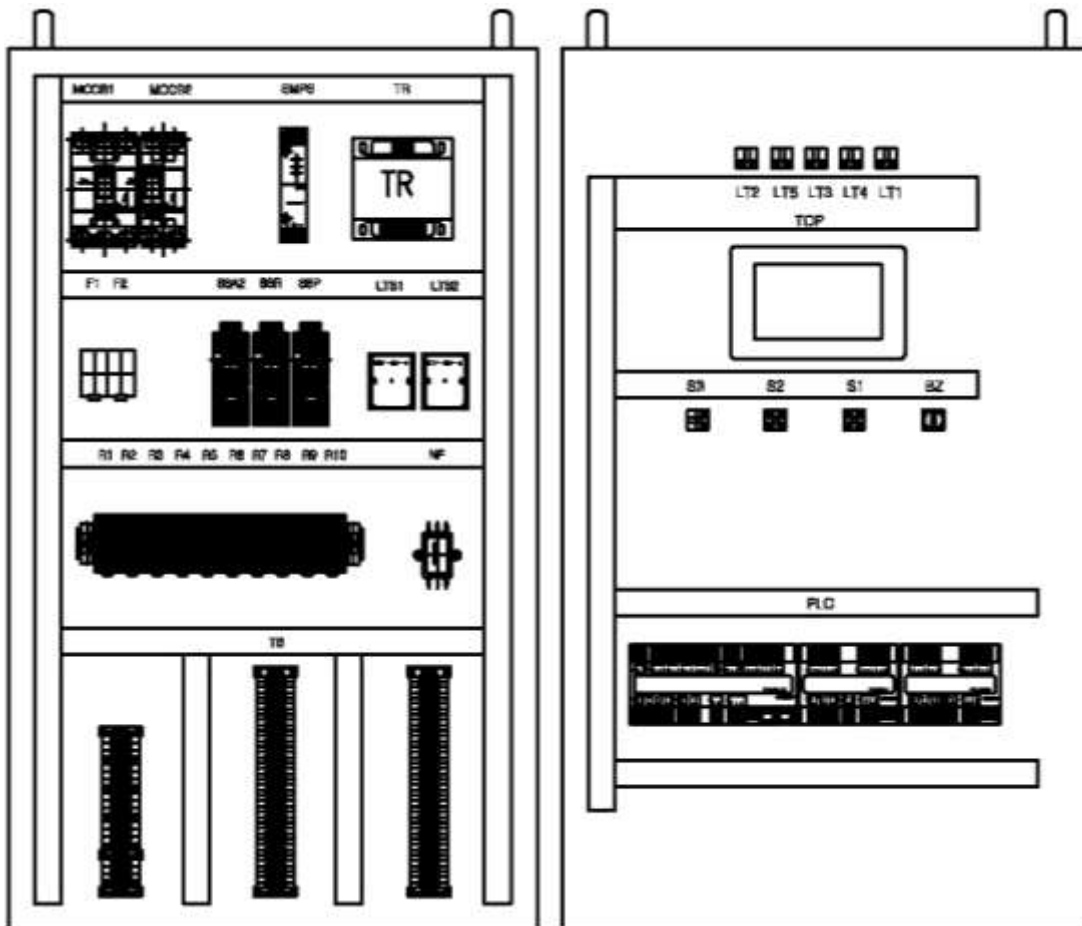

NO.	SYMBOL NAME	NAME OF INSTRUMENT	Q'TY
1	MCCB1	MAIN POWER CIRCUIT BREAKER	1
2	MCCB2	CONTROL CIRCUIT BREAKER	1
3	TR	TRANSFORMER	1
4	88A2	SOLUTION PUMP2 CONTACTOR	1
5	88R	REFRIGERANT PUMP CONTACTOR	1
6	88P	PURGE PUMP CONTACTOR	1
7	51A2	SOLUTION PUMP2 OVERLOAD RELAY	1
8	51R	REFRIGERANT PUMP OVERLOAD RELAY	1
9	51P	PURGE PUMP OVERLOAD RELAY	1
10	F1~F2	POWER FUSE	2
11	R1~R10	RELAY	10
12	NF	NOISE FILTER	1
13	SMPS	DC POWER SUPPLY	1
14	TB	TERMINAL BLOCK	
15	LTS1	G1 LEVEL CONTROL RELAY HIGH	1
16	LTS2	G1 LEVEL CONTROL RELAY LOW	1
17	PLC	CONTROLLER	1
18	LT1~5	PILOT LAMP	5
19	S1~S3	SELECTOR SWITCH	3
20	BZ	BUZZER	1
21	TOP	TOUCH SCREEN	1

# Diverter Valve

## Outline

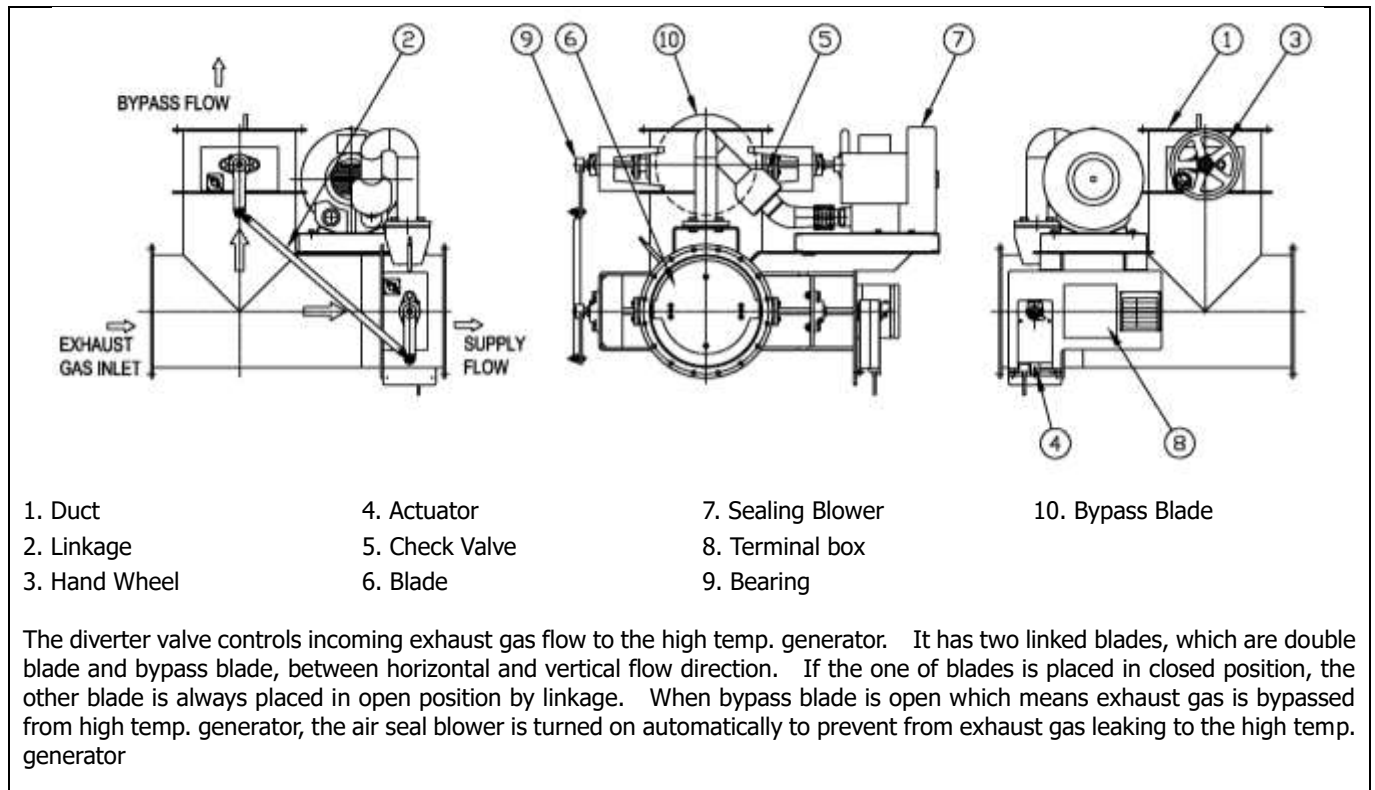

## Installation Guide (Case 1)

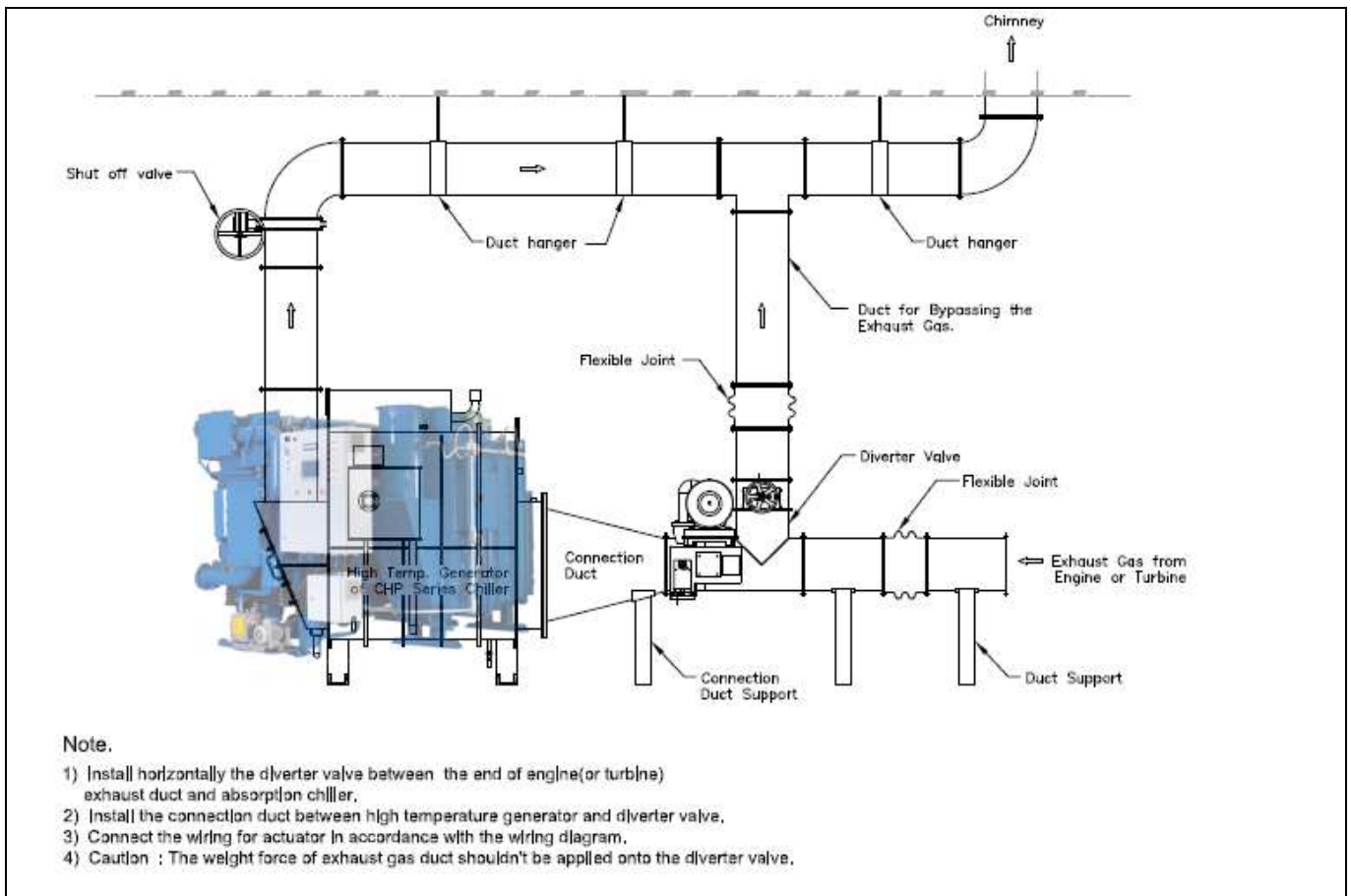

## Installation Guide (Case 2)

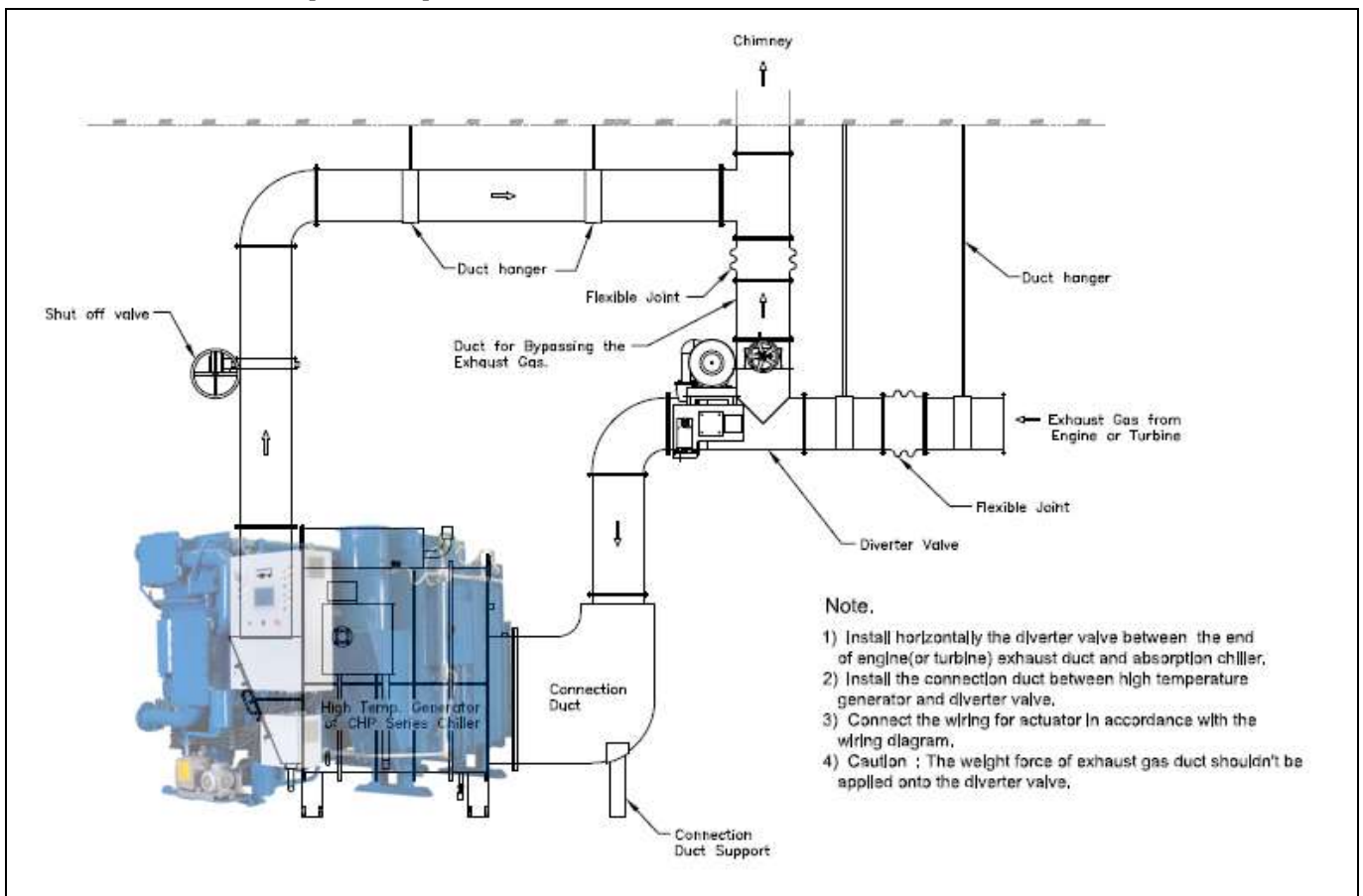

# System Piping

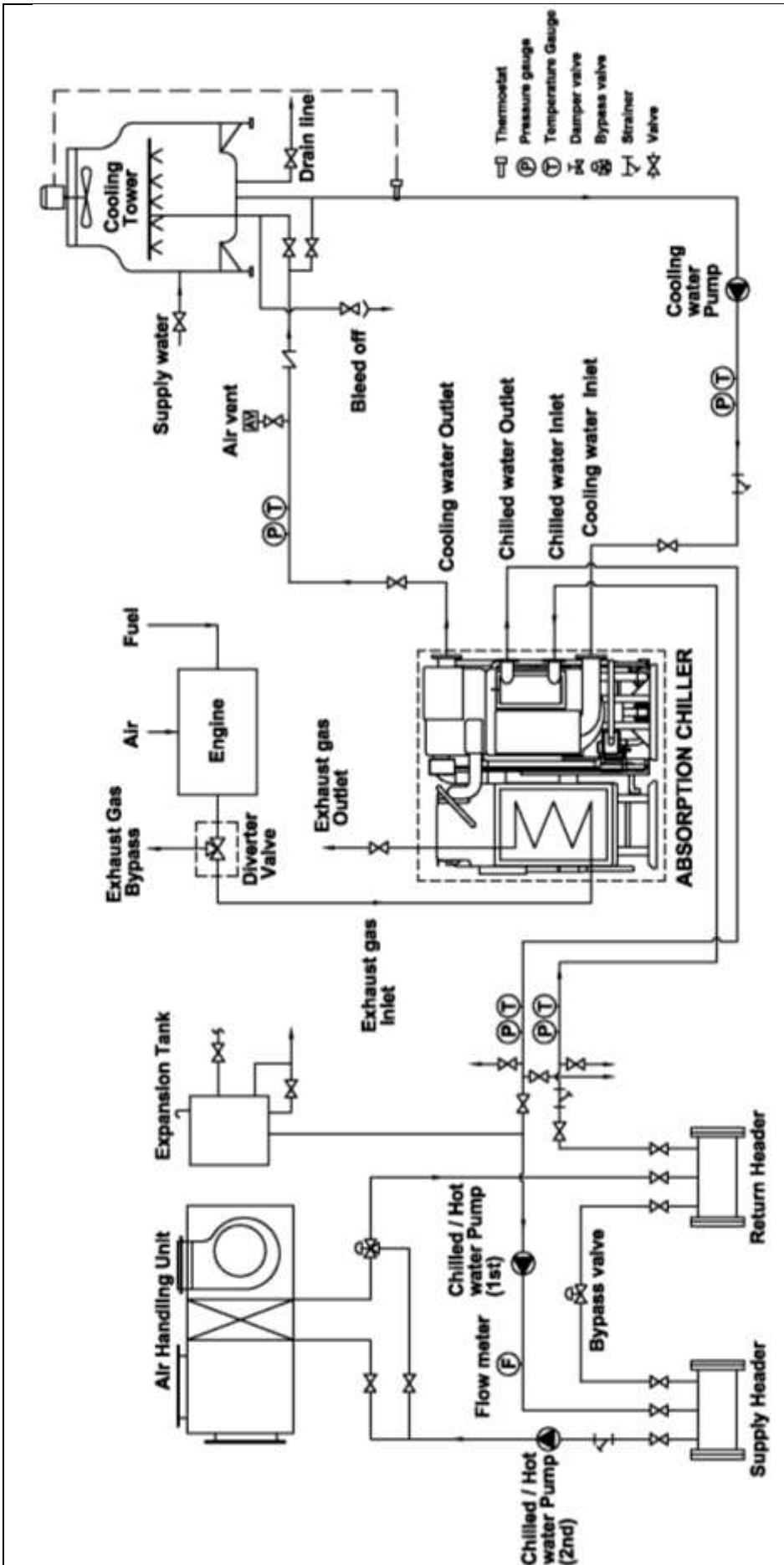





- 1) All external equipment out of dotted line shall not be prepared and provided by Absorption Machine Manufacturer.
- 2) For pipe connections and diameters, please refer to the external dimensional diagrams and specification tables provided separately.
- 3) Installation of diverter valve refer the drawing for installing diverter valve.(Case 1 or Case 2)
- 4) The locations of the chilled water pumps, cooling water pumps and expansion tanks shall be determined in consideration of the hydrostatic head of pumps and the height of building. And the Machine shall not be subject to a pressure larger than the designed pressure at any water headers.
- 5) For cooling water quality control, it is recommended to install cooling water bleed-off device on the inlet pipe line of cooling towers.
- 6) About 10 meshes of strainers shall be installed in the cooling water line.
- 7) For the maintenance and the inspection of the Machine, the following equipment shall be installed on each chilled water and cooling water inlet / outlet lines as well as stop valve.
  - Thermometers and pressure gauges shall be installed at chilled and cooling water inlet / outlet.
  - Air relief valves shall be installed on each chilled and cooling water lines at higher points than each water headers.
  - Drain valves shall be installed at the lowest position between the stop valves of chilled and cooling water and the Machine and the drain valve shall be piped to the drain ditch.
- 8) There shall be a sufficient clearance for access to the absorber, evaporator, and generator To facilitate inspection and cleaning work.





# Thermal Insulations

**INSULATION FOR HOT SURFACES**

-  75mm : High Temp. Generator.
-  50mm : Steam Piping, Box of Low Temp. Generator, Piping of High Temp. Generator(Intel, Outlet), Sides of High Temp. Heat Exchanger
-  19mm : Low Temp. Generator Body and Outlet Box(NGSG), High & Low Temp. Heat Exchanger Body and Box of Heat Exchanger.
-  10mm : Intel & Outlet Piping of Low Temp. Generator.

**INSULATION FOR COLD SURFACES**

-  19mm : Evaporator Body and It's Water Box.
-  10mm : Piping of Refrigerant Pump(Intel, Outlet).

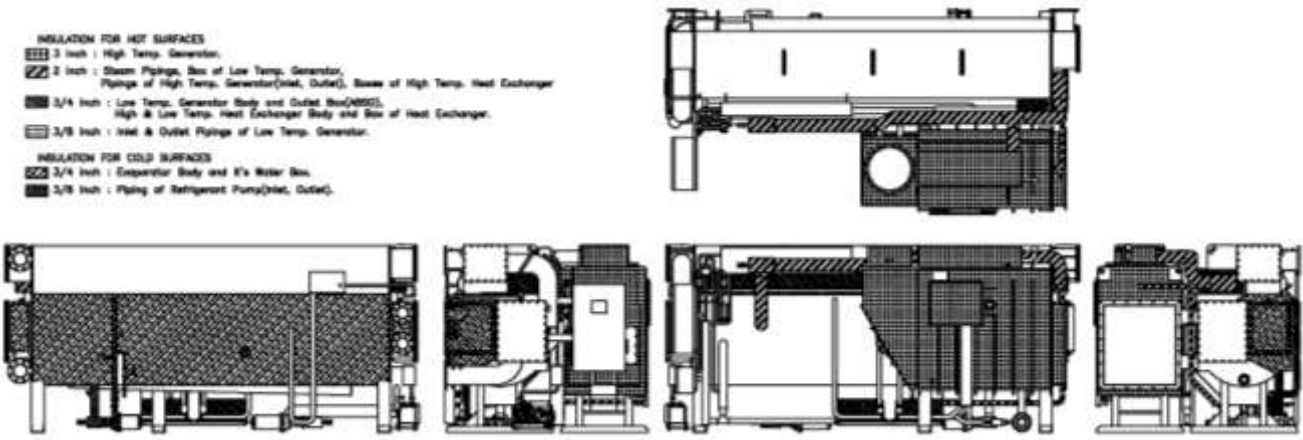

**Notes**

1. Use only non-inflammable or incombustible insulation materials.
2. Do not insulate motor of refrigerant pump and fusible plug
3. Total insulation are includes piping.
4. Do not cover all valves, dampers, sight glasses, temperature sensors and its wells.

Model	Hot Surface (m <sup>2</sup> )				Cold Surface (m <sup>2</sup> )	
	75mm	50mm	19mm	10mm	19mm	10mm
CHP005HH	27	3	9	1	9	1
CHP006HH	27	3	9	1	9	1
CHP007HH	27	3	11	1	9	1
CHP008HH	27	4	11	1	9	1
CHP010HH	31	6	14	2	12	1
CHP012HH	34	6	14	2	12	1
CHP015HH	37	7	21	2	16	1
CHP018HH	37	7	21	2	16	1
CHP021HH	42	7	23	3	19	1
CHP024HH	45	7	23	3	19	1
CHP028HH	46	8	27	4	23	1
CHP032HH	60	8	27	4	23	1
CHP036HH	60	10	30	4	26	1
CHP040HH	60	10	30	4	26	1
CHP045HH	68	10	33	4	26	1
CHP050HH	70	10	33	4	36	1
CHP056HH	77	25	37	5	44	2
CHP063HH	81	27	40	5	49	2
CHP070HH	83	30	43	5	52	2
CHP080HH	105	34	46	5	56	4
CHP090HH	111	38	47	5	61	4
CHP100HH	112	43	49	6	66	4
CHP110HH	120	51	45	6	73	5
CHP120HH	123	55	46	6	74	5
CHP130HH	129	60	47	6	77	5
CHP140HH	135	59	48	6	87	5
CHP150HH	144	64	50	6	91	5

# Water Quality

The cooling water which is recycled by cooling tower is exposed into atmosphere and polluted as it is vaporized. If the cooling water gets polluted, it develops corrosion and also scale inside the tubes and Absorption Machine performance drops.

Therefore, it is recommended to control the water quality; the following table shows guideline for cooling water and make-up water. The tube cleaning method and interval depends on each water quality.

	Items	Cooling Water	Make-up Water	Tendency	
				Corrosion	Scale
<b>Standard</b>	PH(77 °F)	6.5 ~ 8.0	6.5 ~ 8.0	0	0
	Conductivity (77 °F, s/cm)	Max. 800	Max. 200	0	0
	Chloride ion Cl (mg / cl /liter)	Max. 200	Max. 50	0	
	Sulfuric acid ion SO <sub>4</sub> <sup>2-</sup> (mg CaCO <sub>3</sub> /liter)	Max. 200	Max. 50	0	
	Alkalinity pH4.8 (mg CaCO <sub>3</sub> /liter)	Max. 100	Max. 50		0
	Total hardness (mg CaCO <sub>3</sub> /liter)	Max. 200	Max. 50		0
<b>Reference</b>	Iron Fe (77 °F)	Max. 1.0	Max. 0.3	0	
	Sulfides S <sup>2-</sup> ion(ms S <sup>2-</sup> /liter)	No trace	No trace	0	
	Ammonium ion NH <sub>4</sub> <sup>+</sup> (mg NH <sub>4</sub> <sup>+</sup> /liter)	Max. 1.0	Max. 0.2	0	
	Silica SiO (mg SiO <sub>2</sub> /liter)	Max. 50	Max. 30		0



**World Energy Co., Ltd.**

---

10, 24Beon-gil, Daeya1-Ro Gunpo-Si, Gyeonggi-do, 435-060, Korea  
Tel 82-31-501-2706, Fax 82-31-501-2705  
<http://www.worldenergy.co.kr>

---